



# Catalogue 2023

# GENERAL CONTENT

1. Truss systems and accessories
2. System Frame 16 <sup>2</sup>/<sub>3</sub> and 20 plus accessories
3. Turntables and controls
4. Mobile stage wagons and Up2Move
5. Grandstands and telescopic riser
6. Set design and 3D-System frames
7. Fly bar system StarTrack 1 and 2
8. Silent Move track system and accessories
9. Ballet wagon
10. Concert shell

# 1. **HOAC**<sup>®</sup> TRUSS SYSTEM

- 1.1 Box truss
- 1.2 Box truss accessories
- 1.3 Triangular truss
- 1.4 Triangular truss accessories
- 1.5 Ladder truss
- 1.6 Ladder truss accessories
- 1.T Technical data

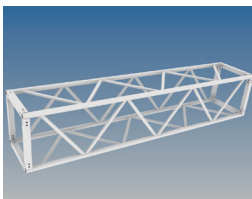

### Box truss 300/4M

Order code	Item no.	Length
K001.500/300/4M	001.10000106.00	500mm
K001.1000/300/4M	001.10000099.00	1000mm
K001.1500/300/4M	001.10000098.00	1500mm
K001.2000/300/4M	001.10000097.00	2000mm
K001.2300/300/4M	001.10000100.00	2300mm
K001.2500/300/4M	001.10000096.00	2500mm
K001.3000/300/4M	001.10000104.00	3000mm
K001.3500/300/4M	001.10000105.00	3500mm
K001.4000/300/4M	001.10000095.00	4000mm
K001.4500/300/4M	001.10000094.00	4500mm
K001.5000/300/4M	001.10000103.00	5000mm

### Box truss 300/4S

Order code	Item no.	Length
K001.500/300/4S	001.10000117.00	500mm
K001.1000/300/4S	001.10000116.00	1000mm
K001.1500/300/4S	001.10000115.00	1500mm
K001.2000/300/4S	001.10000114.00	2000mm
K001.2300/300/4S	001.10000113.00	2300mm
K001.2500/300/4S	001.10000112.00	2500mm
K001.3000/300/4S	001.10000107.00	3000mm
K001.3500/300/4S	001.10000108.00	3500mm
K001.4000/300/4S	001.10000109.00	4000mm
K001.4500/300/4S	001.10000110.00	4500mm
K001.5000/300/4S	001.10000111.00	5000mm

All trusses come with a full set of M12 bolts and nuts incl. a pair of washers.  
 Beside the standard we also manufacture different sizes and dimensions.  
 Powder coating in any RAL or NTSC code is possible.  
 For outside use we recommend Nirosta bolts and nuts.

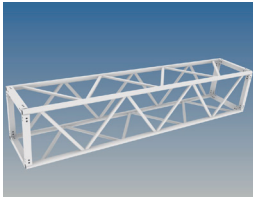

## Box truss 500/4

Order code	Item no.	Length
K001.500/500/4	001.10000131.00	500mm
K001.1000/500/4	001.10000130.00	1000mm
K001.1500/500/4	001.10000129.00	1500mm
K001.1900/500/4	001.10000123.00	1900mm
K001.2000/500/4	001.10000128.00	2000mm
K001.2500/500/4	001.10000127.00	2500mm
K001.3000/500/4	001.10000126.00	3000mm
K001.3500/500/4	001.10000125.00	3500mm
K001.4000/500/4	001.10000122.00	4000mm
K001.4500/500/4	001.10000132.00	4500mm
K001.5000/500/4	001.10000124.00	5000mm

## Box truss 700/4

Order code	Item no.	Length
K001.1000/700/4	001.10000141.00	1000mm
K001.1500/700/4	001.10000140.00	1500mm
K001.2000/700/4	001.10000139.00	2000mm
K001.2500/700/4	001.10000133.00	2500mm
K001.3000/700/4	001.10000134.00	3000mm
K001.3500/700/4	001.10000135.00	3500mm
K001.4000/700/4	001.10000136.00	4000mm
K001.4500/700/4	001.10000137.00	4500mm
K001.5000/700/4	001.10000138.00	5000mm

All trusses come with a full set of M12 bolts and nuts incl. a pair of washers.  
Beside the standard we also manufacture different sizes and dimensions.  
Powder coating in any RAL or NTSC code is possible.  
For outside use we recommend Nirosta bolts and nuts.

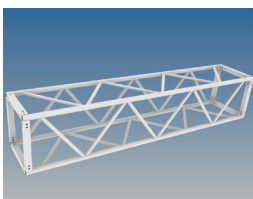

### Accessories Box truss 300/4M

Order code	Item no.	Description
K001.CB300/4M	001.10000150.00	6-way corner
K001.CO300/4M	001.10000078.00	Corner 90°
K001.TJ300/4M	001.10000004.00	T-Joint
K001.WB300/4	001.10000145.00	Wall bracket
K001.KA300/4M	001.10000066.00	Extra single connection
K001.DKA300/4M	001.10000067.00	Extra double connection
K001.TH300/3-4	001.10000061.00	Gizmo

### Accessories Box truss 300/4S

Order code	Item no.	Description
K001.CB300/4S	001.10000151.00	6-way corner
K001.CO300/4S	001.10000079.00	Corner 90°
K001.TJ300/4S	001.10000005.00	T-Joint
K001.WB300/4	001.10000145.00	Wall bracket
K001.KA300/4S	001.10000068.00	Extra single connection
K001.DKA300/4S	001.10000069.00	Extra double connection
K001.TH300/3-4	001.10000061.00	Gizmo

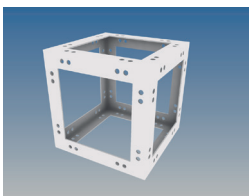

K001.CB300/4M

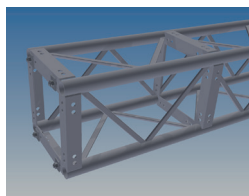

K001.KA300/4M

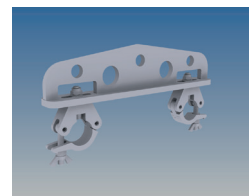

K001.TH300/3-4

## Accessories Box truss 500/4

Order code	Item no.	Description
K001.CB500/4	001.10000152.00	6-way corner
K001.CO500/4	001.10000081.00	Corner 90°
K001.TJ500/4	001.10000007.00	T-Joint
K001.WB500/4	001.10000147.00	Wall bracket
K001.KA500/4	001.10000071.00	Extra single connection
K001.DKA500/4	001.10000072.00	Extra double connection
K001.TH500/3-4	001.10000062.00	Gizmo

## Accessories Box truss 700/4

Order code	Item no	Description
K001.CB700/4	001.10000153.00	6-way corner
K001.CO700/4	001.10000083.00	Corner 90°
K001.TJ700/4	001.10000009.00	T-Joint
K001.WB700/4	001.10000149.00	Wall bracket
K001.KA700/4	001.10000074.00	Extra single connection
K001.DKA700/4	001.10000075.00	Extra double connection
K001.TH700/3-4	001.10000063.00	Gizmo

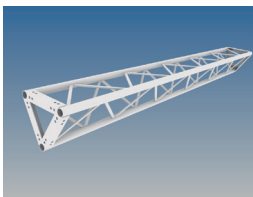

### Triangular truss 300/3M

Order code	Item no.	Length
K001.500/300/3M	001.10000022.00	500mm
K001.1000/300/3M	001.10000010.00	1000mm
K001.1500/300/3M	001.10000011.00	1500mm
K001.2000/300/3M	001.10000012.00	2000mm
K001.2100/300/3M	001.10000013.00	2100mm
K001.2500/300/3M	001.10000014.00	2500mm
K001.3000/300/3M	001.10000015.00	3000mm
K001.3500/300/3M	001.10000016.00	3500mm
K001.4000/300/3M	001.10000017.00	4000mm
K001.4500/300/3M	001.10000018.00	4500mm
K001.5000/300/3M	001.10000019.00	5000mm

### Triangular truss 300/3S

Order code	Item no.	Length
K001.500/300/3S	001.10000023.00	500mm
K001.1000/300/3S	001.10000024.00	1000mm
K001.1500/300/3S	001.10000025.00	1500mm
K001.2000/300/3S	001.10000026.00	2000mm
K001.2100/300/3S	001.10000027.00	2100mm
K001.2500/300/3S	001.10000028.00	2500mm
K001.3000/300/3S	001.10000029.00	3000mm
K001.3500/300/3S	001.10000030.00	3500mm
K001.4000/300/3S	001.10000031.00	4000mm
K001.4500/300/3S	001.10000032.00	4500mm
K001.5000/300/3S	001.10000033.00	5000mm

All trusses come with a full set of M12 bolts and nuts incl. a pair of washers.  
 Beside the standard we also manufacture different sizes and dimensions.  
 Powder coating in any RAL or NTSC code is possible.  
 For outside use we recommend Nirosta bolts and nuts.



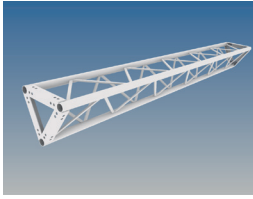

### Triangular truss 500/3

Order code	Item no.	Length
K001.500/500/3	001.10000048.00	500mm
K001.1000/500/3	001.10000047.00	1000mm
K001.1500/500/3	001.10000036.00	1500mm
K001.1700/500/3	001.10000037.00	1700mm
K001.2000/500/3	001.10000038.00	2000mm
K001.2500/500/3	001.10000039.00	2500mm
K001.3000/500/3	001.10000040.00	3000mm
K001.3500/500/3	001.10000041.00	3500mm
K001.4000/500/3	001.10000042.00	4000mm
K001.4500/500/3	001.10000043.00	4500mm
K001.5000/500/3	001.10000044.00	5000mm

### Triangular truss 700/3

Order code	Item no.	Length
K001.1000/700/3	001.10000053.00	1000mm
K001.1300/700/3	001.10000054.00	1300mm
K001.1500/700/3	001.10000052.00	1500mm
K001.2000/700/3	001.10000049.00	2000mm
K001.2500/700/3	001.10000051.00	2500mm
K001.3000/700/3	001.10000050.00	3000mm
K001.3500/700/3	001.10000055.00	3500mm
K001.4000/700/3	001.10000056.00	4000mm
K001.4500/700/3	001.10000057.00	4500mm
K001.5000/700/3	001.10000058.00	5000mm

All trusses come with a full set of M12 bolts and nuts incl. a pair of washers.  
Beside the standard we also manufacture different sizes and dimensions.  
Powder coating in any RAL or NTSC code is possible.  
For outside use we recommend Nirosta bolts and nuts.

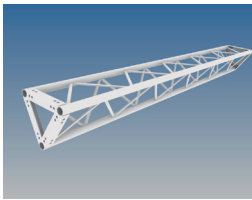

### Accessories triangular truss 300/3M

Order code	Item no.	Description
K001.CO300/3M	001.10000076.00	Verbinder 90°
K001.COP300/3M	001.10000084.00	Verbinder 90° für Projektion
K001.TJ300/3M	001.10000002.00	Dreifachabgang
K001.WB300/3	001.10000144.00	Wandkonsole
K001.TH300/3-4	001.10000061.00	Gizmo

### Accessories triangular truss 300/3S

Order code	Item no.	Description
K001.CO300/3S	001.10000077.00	Verbinder 90°
K001.COP300/3S	001.10000085.00	Verbinder 90° für Projektion
K001.TJ300/3S	001.10000003.00	Dreifachabgang
K001.WB300/3	001.10000144.00	Wandkonsole
K001.TH300/3-4	001.10000061.00	Gizmo

### Accessories triangular truss 500/3

Order code	Item no.	Description
K001.CO500/3	001.10000080.00	Verbinder 90°
K001.COP500/3	001.10000086.00	Verbinder 90° für Projektion
K001.TJ500/3	001.10000006.00	Dreifachabgang
K001.WB500/3	001.10000146.00	Wandkonsole
K001.TH500/3-4	001.10000062.00	Gizmo

### Accessories triangular truss 700/3

Order code	Item no.	Description
K001.CO700/3	001.10000082.00	Verbinder 90°
K001.COP700/3	001.10000087.00	Verbinder 90° für Projektion
K001.TJ700/3	001.10000008.00	Dreifachabgang
K001.WB700/3	001.10000148.00	Wandkonsole
K001.TH700/3-4	001.10000063.00	Gizmo

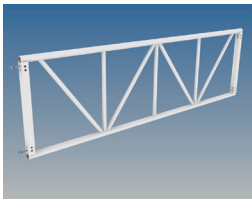

### Ladder truss 300/2M

Order code	Item no.	Length
K001.500/300/2M	001.10000158.00	500mm
K001.1000/300/2M	001.10000159.00	1000mm
K001.1500/300/2M	001.10000160.00	1500mm
K001.2000/300/2M	001.10000161.00	2000mm
K001.2300/300/2M	001.10000162.00	2300mm
K001.2500/300/2M	001.10000155.00	2500mm
K001.3000/300/2M	001.10000163.00	3000mm
K001.3500/300/2M	001.10000164.00	3500mm
K001.4000/300/2M	001.10000165.00	4000mm
K001.4500/300/2M	001.10000166.00	4500mm
K001.5000/300/2M	001.10000167.00	5000mm

### Ladder truss 300/2S

Order code	Item no.	Length
K001.500/300/2S	001.10000170.00	500mm
K001.1000/300/2S	001.10000171.00	1000mm
K001.1500/300/2S	001.10000172.00	1500mm
K001.2000/300/2S	001.10000173.00	2000mm
K001.2300/300/2S	001.10000176.00	2300mm
K001.2500/300/2S	001.10000174.00	2500mm
K001.3000/300/2S	001.10000175.00	3000mm
K001.3500/300/2S	001.10000177.00	3500mm
K001.4000/300/2S	001.10000178.00	4000mm
K001.4500/300/2S	001.10000179.00	4500mm
K001.5000/300/2S	001.10000180.00	5000mm

All trusses come with a full set of M12 bolts and nuts incl. a pair of washers.  
 Beside the standard we also manufacture different sizes and dimensions.  
 Powder coating in any RAL or NTSC code is possible.  
 For outside use we recommend Nirosta bolts and nuts.

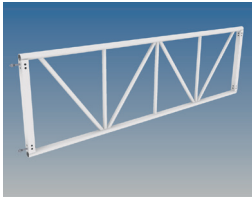

## Ladder truss 500/2

Order code	Item no.	Length
K001.500/500/2	001.10000184.00	500mm
K001.1000/500/2	001.10000183.00	1000mm
K001.1500/500/2	001.10000185.00	1500mm
K001.1900/500/2	001.10000186.00	1900mm
K001.2000/500/2	001.10000187.00	2000mm
K001.2500/500/2	001.10000188.00	2500mm
K001.3000/500/2	001.10000189.00	3000mm
K001.3500/500/2	001.10000190.00	3500mm
K001.4000/500/2	001.10000191.00	4000mm
K001.4500/500/2	001.10000192.00	4500mm
K001.5000/500/2	001.10000193.00	5000mm

## Ladder truss 700/2

Order code	Item no.	Length
K001.1000/700/2	001.10000198.00	1000mm
K001.1500/700/2	001.10000197.00	1500mm
K001.2000/700/2	001.10000196.00	2000mm
K001.2500/700/2	001.10000206.00	2500mm
K001.3000/700/2	001.10000199.00	3000mm
K001.3500/700/2	001.10000200.00	3500mm
K001.4000/700/2	001.10000201.00	4000mm
K001.4500/700/2	001.10000202.00	4500mm
K001.5000/700/2	001.10000203.00	5000mm

All trusses come with a full set of M12 bolts and nuts incl. a pair of washers.  
Beside the standard we also manufacture different sizes and dimensions.  
Powder coating in any RAL or NTSC code is possible.  
For outside use we recommend Nirosta bolts and nuts.

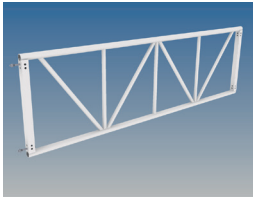

### Accessories ladder truss 300/2M

Order code	Item no.	Description
K001.KA300/2M	001.10000064.00	Extra single connection
K001.TH300-700/2	590.10000036.00	Doughty O-Ring

### Accessories ladder truss 300/2S

Order code	Item no.	Description
K001.KA300/2S	001.10000065.00	Extra single connection
K001.TH300-700/2	590.10000036.00	Doughty O-Ring

### Accessories ladder truss 500/2

Order code	Item no.	Description
K001.KA500/2	001.10000070.00	Extra single connection
K001.TH300-700/2	590.10000036.00	Doughty O-Ring

### Accessories ladder truss 700/2

Order code	Item no.	Description
K001.KA700/2	001.10000073.00	Extra single connection
K001.TH300-700/2	590.10000036.00	Doughty O-Ring

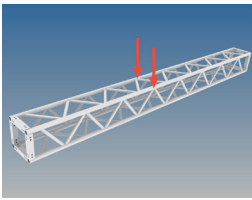

### Load table point load box truss F(kN)

System	2m	3m	4m	5m	6m	7m	8m	9m
300/4M	8,47	8,42	7,48	5,94	4,90	4,15	3,58	3,14
300/4S	12,25	11,44	9,90	7,83	6,44	5,44	4,67	4,06
500/4	12,94	12,48	11,82	11,26	10,64	9,32	8,08	7,11
700/4								

System	10m	11m	12m	13m	14m	15m	16m	17m
300/4M	2,77	2,47	2,22	2,00	1,80	1,63	1,48	
300/4S	3,57	3,16	2,81	2,50	2,23	2,00	1,78	
500/4	6,32	5,67	5,12	4,65	4,24	3,89	3,57	
700/4								

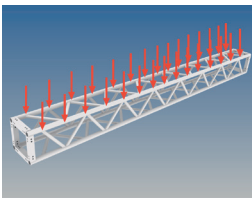

### Load table distributed load box truss p(kN/m)

System	2m	3m	4m	5m	6m	7m	8m	9m
300/4M	4,23	2,80	2,09	1,66	1,37	1,17	0,89	0,69
300/4S	10,43	6,92	4,95	3,13	2,14	1,55	1,16	0,90
500/4	10,42	6,92	5,17	4,13	3,40	2,66	2,02	1,58
700/4	10,59	7,03	5,25	4,19	3,48	2,97	2,59	2,29

System	10m	11m	12m	13m	14m	15m	16m	17m
300/4M	0,55	0,45	0,37	0,30	0,25	0,21	0,18	
300/4S	0,71	0,57	0,46	0,38	0,32	0,26	0,22	
500/4	1,26	1,03	0,85	0,71	0,60	0,51	0,44	
700/4								

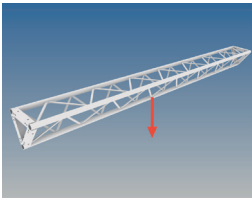

### Load table point load triangular truss F(kN)

System	2m	3m	4m	5m	6m	7m	8m	9m
300/3M								
300/3S								
500/3	10,42	9,39	7,11	5,62	4,61	3,88	3,32	2,87
700/3								

System	10m	11m	12m	13m	14m	15m	16m	17m
300/3M								
300/3S								
500/3	2,51	2,21	1,95	1,72	1,52	1,34	1,18	
700/3								

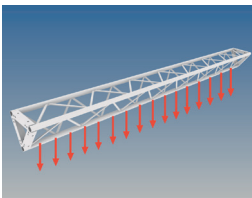

### Load table distributed load triangular truss p(kN/m)

System	2m	3m	4m	5m	6m	7m	8m	9m
300/3M								
300/3S								
500/3	9,02	6,00	3,56	2,25	1,53	1,10	0,83	0,64
700/3								

System	10m	11m	12m	13m	14m	15m	16m	17m
300/3M								
300/3S								
500/3	0,50	0,40	0,32	0,26	0,21	0,18	0,14	
700/3								

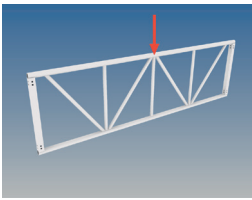

### Load table point load ladder truss F(kN)

System	2m	3m	4m	5m	6m	7m	8m	9m
300/2M								
300/2S								
500/2	6,40	3,32	1,37	0,70	0,39			
500/2 supported 2m	6,40	6,14	4,72	3,71	3,01	2,51	2,12	1,81

System	10m	11m	12m	13m	14m	15m	16m	17m
300/2M								
300/2S								
500/2 supported 2m	1,55	1,34	1,15	0,99	0,84	0,71	0,59	
700/2								

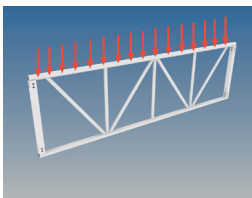

### Load table distributed load ladder truss p(kN/m)

System	2m	3m	4m	5m	6m	7m	8m	9m
300/2M								
300/2S								
500/2	5,17	2,05	0,68	0,28	0,13			
500/2 supported 2m	5,17	3,43	2,36	1,48	1,00	0,71	0,53	0,40

System	10m	11m	12m	13m	14m	15m	16m	17m
300/2M								
300/2S								
500/2 supported	0,31	0,24	0,19	0,15	0,12	0,09	0,07	
700/2								



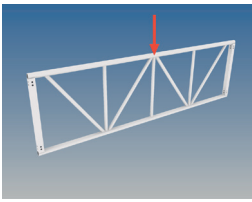

## Weight table truss systems (Kg)

System	1000mm	1500mm	2000mm	2500mm	3000mm	3500mm	4000m
300/4M	8,6	11,6	14,7	17,5	20,5	23,5	26,6
300/4S	13,6	17,2	20,8	24,4	28,0	31,5	35,1
500/4	17,0	20,6	24,2	27,7	32,0	35,5	39,0
700/4	22,2	25,0	30,1	35,2	40,3	43,2	48,3

System	1000mm	1500mm	2000mm	2500mm	3000mm	3500mm	4000m
300/3M	6,6	8,7	11,0	13,2	15,5	17,8	20,0
300/3S	10,4	12,8	15,8	18,4	21,2	23,9	26,6
500/3	13,0	15,7	18,4	21,0	24,2	26,8	29,0
700/3	16,9	19,0	22,8	26,6	30,5	32,6	36,5

System	1000mm	1500mm	2000mm	2500mm	3000mm	3500mm	4000m
300/2M	3,4	4,8	6,1	7,4	8,7	10,0	11,4
300/2S	4,7	6,2	7,7	9,0	10,5	12,0	13,5
500/2	5,6	7,0	8,5	10,0	11,5	12,9	14,4
700/2	6,9	8,2	10,0	11,9	13,7	15,0	16,9

## Weight table truss accessories (Kg)

System	corner
300/4M	5,2
300/4S	10,9
500/4	15,7
700/4	22,8

## 2. **HOAC**<sup>®</sup> PLATFORMS & STAGING

- 2.1 System frame 16 <sup>2</sup>/<sub>3</sub>
- 2.2 System frame 20
- 2.3 System frame triangular 16 <sup>2</sup>/<sub>3</sub> and 20
- 2.4 Profiles and accessories
- 2.5 Single legs and accessories
- 2.6 Single telescopic legs with eccentric bolt
- 2.7 Single telescopic legs and accessories
- 2.8 Telescopic V-frames and accessories
- 2.9 V-frame single parts
- 2.10 Bracing for V-frame
- 2.11 Decks
- 2.12 Deck accessories
- 2.13 Railings
- 2.T Technical data

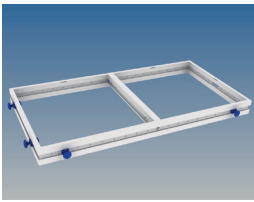

## System frame 16 <sup>2</sup>/<sub>3</sub> standard including cross bar and connector

Order code	Item no.	Length	Width	Cross bars	Link blocks
K002.Z1/1-16	002.10001091.00	1000mm	1000mm	0	4
K002.Z2/1-16	002.10001052.00	2000mm	1000mm	1	4
K002.Z3/1-16	002.10001092.00	3000mm	1000mm	2	5
K002.Z4/1-16	002.10001093.00	4000mm	1000mm	3	6
K002.Z5/1-16	002.10001095.00	5000mm	1000mm	4	7
K002.Z6/1-16	002.10001096.00	6000mm	1000mm	5	8
K002.Z0/0-16	002.10001103.00	500mm	500mm	0	2
K002.Z1/0-16	002.10001101.00	1000mm	500mm	0	3
K002.Z2/0-16	002.10001100.00	2000mm	500mm	1	3
K002.Z3/0-16	002.10001099.00	3000mm	500mm	2	4
K002.Z4/0-16	002.10001098.00	4000mm	500mm	3	5
K002.Z5/0-16	002.10001097.00	5000mm	500mm	4	6
K002.Z6/0-16	002.10001053.00	6000mm	500mm	5	7

All frames come with a full set of link blocks and cross bars.  
 Besides the standard we manufacture also different sizes and shapes.  
 Powder coating in any RAL or NTSC code is possible.

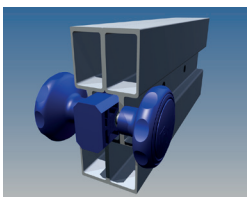

K002.ZE04

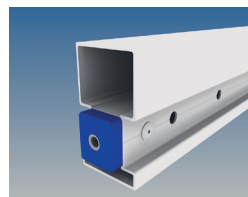

K002.ZR1000

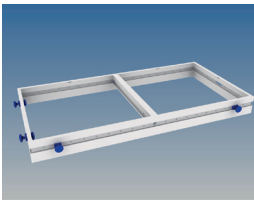

## System frame 20 standard including cross bar and connector

Order code	Item no.	Length	Width	Cross bars	Link blocks
K002.Z1/1-20	002.10001237.00	1000mm	1000mm	0	4
K002.Z2/1-20	002.10001238.00	2000mm	1000mm	1	4
K002.Z3/1-20	002.10001239.00	3000mm	1000mm	2	5
K002.Z4/1-20	002.10001240.00	4000mm	1000mm	3	6
K002.Z5/1-20	002.10001241.00	5000mm	1000mm	4	7
K002.Z6/1-20	002.10001242.00	6000mm	1000mm	5	8
K002.Z0/0-20	002.10001236.00	500mm	500mm	0	2
K002.Z1/0-20	002.10001248.00	1000mm	500mm	0	3
K002.Z2/0-20	002.10001249.00	2000mm	500mm	1	3
K002.Z3/0-20	002.10001250.00	3000mm	500mm	2	4
K002.Z4/0-20	002.10001251.00	4000mm	500mm	3	5
K002.Z5/0-20	002.10001252.00	5000mm	500mm	4	6
K002.Z6/0-20	002.10001253.00	6000mm	500mm	5	7

All frames come with a full set of link blocks and cross bars.  
 Beside the standard we also manufacture different sizes and shapes.  
 Powder coating in any RAL or NTSC code is possible.

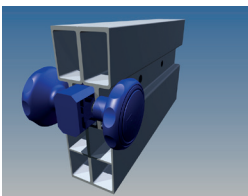

K002.ZE04

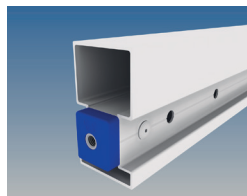

K002.ZR1000

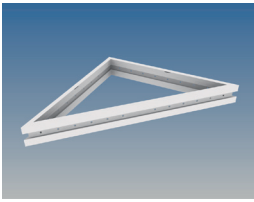

### System frame 16 <sup>2</sup>/<sub>3</sub> triangular including welded cross bar and connector

Order code add L/R	Item no.	Length	Width	Cross bars	Link blocks
K002.Z1/1E-16	002.10001104.00	1000mm	1000mm	0	4
K002.Z2/1E-16R	002.10001109.00	2000mm	1000mm	1	4
K002.Z2/1E-16L	002.10001108.00	2000mm	1000mm	1	4

### System frame 20 triangular including welded cross bar and connector

Order code add L/R	Item no.	Length	Width	Cross bars	Link blocks
K002.Z1/1E-20	002.10001267.00	1000mm	1000mm	0	4
K002.Z2/1E-20R	002.10001271.00	2000mm	1000mm	1	4
K002.Z2/1E-20L	002.10001270.00	2000mm	1000mm	1	4

Add the L or R behind the order code for the left and right triangular frame.  
 All frames come with a full set of link blocks and cross bars.  
 Beside the standard we manufacture also different sizes and shapes.  
 Powder coating in any RAL or NTSC code is possible.



K002.Z1/1E

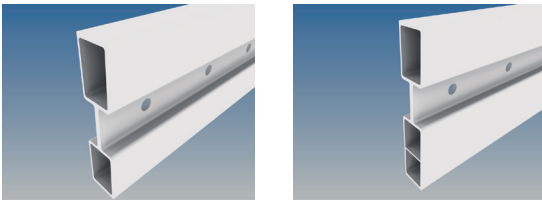

## System profiles

Order code	Item no.	Description	Length
K002.Z16-6	110.10000113.00	System frame profile 16 <sup>2</sup> / <sub>3</sub>	6055mm
K002.Z16-G6	002.10001105.00	System frame profile 16 <sup>2</sup> / <sub>3</sub> , incl. 12mm holes	6055mm
K002.Z20-6	110.10000135.00	System frame profile 20	6055mm
K002.Z20-G6	002.10001243.00	System frame profile 20, incl. 12mm holes	6055mm
00.CB		Cost for bending 6m length (min. radius 1000)	
00.CC		Cost for each (45° - 90°)	

Single profiles are only sold in full lengths. We can cut 45° up to 90°, Oddment enclosed.

## System frame 16 <sup>2</sup>/<sub>3</sub> and 20 accessories

Order code	Item no.	Description	Length
K002.ZE04	002.10000118.00	Link block incl. 2x M10 Star Knob Bolt	
K002.ZR1000	002.10001024.00	Cross bar for 1m frame incl. 2x bolt M10x18	940mm
K002.ZR500	002.10001030.00	Cross bar for 0.5m frame incl. 2x bolt M10x18	440mm
K002.ZE05	002.10000039.00	Corner connector 90° incl. 2x bolt M10x18	
K002.ZSHS	002.10000134.00	Leg holder corner position	
K002.ZSHSG	002.10000135.00	Leg holder side frame position	
K002.TWIST2LOCK	630.10000088.00	Twist2Lock with M10 thread	
K002.TWIST2CLAD	630.10000089.00	Twist2Clad for 12mm front panels	

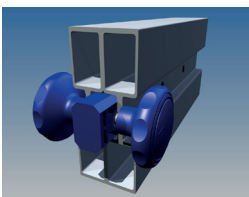

K002.ZE04

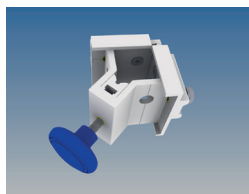

K002.ZSHS

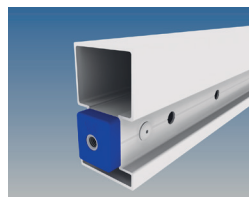

K002.ZR1000

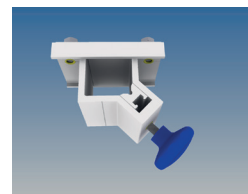

K002.ZSHSG



K002.ZE05

Mistakes and changes are reserved

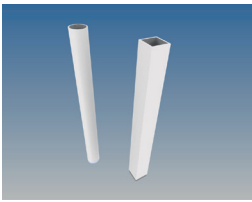

**Attention:**

All numbers about the length of a leg or the height of a platform refer to the total height of the platform applying our 21mm plywood board with a 3mm felt layer between the frame and the board.

**Single legs Ø48mm or 50x50mm incl. M12 plastic plug**

Length (mm) Stage height	Order code Ø48mm x 3mm	Item no.
200mm	K002.ZS20R	002.10000076.00
333mm	K002.ZS33R	002.10000077.00
400mm	K002.ZS40R	002.10000078.00
500mm	K002.ZS50R	002.10000079.00
600mm	K002.ZS60R	002.10000080.00
666mm	K002.ZS66R	002.10000081.00
800mm	K002.ZS80R	002.10000082.00
833mm	K002.ZS83R	002.10000083.00
1000mm	K002.ZS100R	002.10000084.00
1166mm	K002.ZS116R	002.10000085.00
1200mm	K002.ZS120R	002.10000086.00
1333mm	K002.ZS133R	002.10000087.00
1400mm	K002.ZS140R	002.10000088.00
1500mm	K002.ZS150R	002.10000089.00

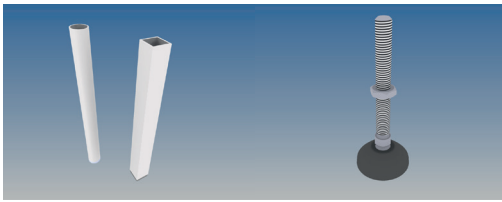
Length (mm) Stage height	Order code 50mm x 50mm x 4mm	Item no.
200mm	K002.ZS20	002.10000062.00
333mm	K002.ZS33	002.10000063.00
400mm	K002.ZS40	002.10000064.00
500mm	K002.ZS50	002.10000065.00
600mm	K002.ZS60	002.10000066.00
666mm	K002.ZS66	002.10000067.00
800mm	K002.ZS80	002.10000068.00
833mm	K002.ZS83	002.10000069.00
1000mm	K002.ZS100	002.10000070.00
1166mm	K002.ZS116	002.10000071.00
1200mm	K002.ZS120	002.10000072.00
1333mm	K002.ZS133	002.10000073.00
1400mm	K002.ZS140	002.10000074.00
1500mm	K002.ZS150	002.10000075.00



**Attention:**

All numbers about the length of a leg or the height of a platform refer to the total height of the platform applying our 21mm plywood board with a 3mm felt layer between the frame and the board.

Single legs Ø48mm or 50x50mm incl. M12 plastic plug and adjustable leveling foot, range ± 35mm

Length (mm) Stage height	Order code Ø48mm x 3mm	Item no.
200mm	K002.ZS20RN	002.20000975.00
333mm	K002.ZS33RN	002.20001237.00
400mm	K002.ZS40RN	002.20001239.00
500mm	K002.ZS50RN	002.20001241.00
600mm	K002.ZS60RN	002.20001263.00
666mm	K002.ZS66RN	002.20001265.00
800mm	K002.ZS80RN	002.20001267.00
833mm	K002.ZS83RN	002.20001269.00
1000mm	K002.ZS100RN	002.20001271.00
1166mm	K002.ZS116RN	002.20001273.00
1200mm	K002.ZS120RN	002.20001275.00
1333mm	K002.ZS133RN	002.20001277.00
1400mm	K002.ZS140RN	002.20001279.00
1500mm	K002.ZS150RN	002.20001281.00

Length (mm) Stage height	Order code 50mm x 50mm x 4mm	Item no.
200mm	K002.ZS20N	002.20000974.00
333mm	K002.ZS33N	002.20001236.00
400mm	K002.ZS40N	002.20001238.00
500mm	K002.ZS50N	002.20001240.00
600mm	K002.ZS60N	002.20001262.00
666mm	K002.ZS66N	002.20001264.00
800mm	K002.ZS80N	002.20001266.00
833mm	K002.ZS83N	002.20001268.00
1000mm	K002.ZS100N	002.20001270.00
1166mm	K002.ZS116N	002.20001272.00
1200mm	K002.ZS120N	002.20001274.00
1333mm	K002.ZS133N	002.20001276.00
1400mm	K002.ZS140N	002.20001278.00
1500mm	K002.ZS150N	002.20001280.00

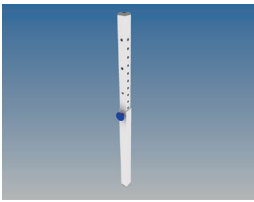

**Attention:**

All numbers about the length of a leg or the height of a platform refer to the total height of the platform applying our 21mm plywood board with a 3mm felt layer between the frame and the board.

**Telescopic single leg with eccentric bolt**

Order code	Item no.	Description	length
K002.ZTL40	002.10000167.00	Telescopic leg with eccentric bolt 40/45	400mm - 450mm
K002.ZTL45	002.10000168.00	Telescopic leg with eccentric bolt 45/50	450mm - 500mm
K002.ZTL50	002.10000169.00	Telescopic leg with eccentric bolt 50/65	500mm - 650mm
K002.ZTL60	002.10000170.00	Telescopic leg with eccentric bolt 60/85	600mm - 850mm
K002.ZTL80	002.10000171.00	Telescopic leg with eccentric bolt 80/120	800mm - 1200mm
K002.ZTL100	002.10000166.00	Telescopic leg with eccentric bolt 100/160	1000mm - 1600mm

min. range stage top

K002.ZTLB40/45	002.10000174.00	Single leg bottom part 40/45	400mm
K002.ZTLB50	002.10000175.00	Single leg bottom part 50	500mm
K002.ZTLB60	002.10000176.00	Single leg bottom part 60	600mm
K002.ZTLB80	002.10000177.00	Single leg bottom part 80	800mm
K002.ZTLB100	002.10000172.00	Single leg bottom part 100	1000mm

adjustable 0-

K002.ZTLT5	002.10000009.00	Single leg / V-frame top part 5	50mm
K002.ZTLT10	002.10000005.00	Single leg / V-frame top part 10	100mm
K002.ZTLT15	002.10000006.00	Single leg / V-frame top part 15	150mm
K002.ZTLT25	002.10000007.00	Single leg / V-frame top part 25	250mm
K002.ZTLT40	002.10000008.00	Single leg / V-frame top part 40	400mm
K002.ZTLT60	002.10000010.00	Single leg / V-frame top part 60	600mm

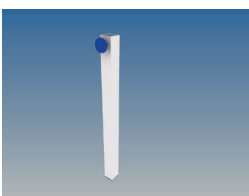

K002.ZTLB



K002.ZTLT

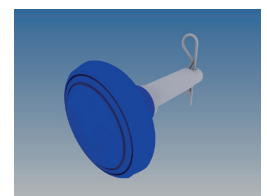

K002.ZEB

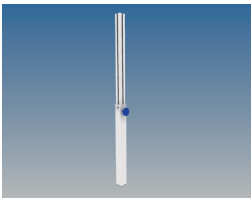

## Single telescopic legs

Order code	Item no.	Description	Length
K002.ZV38-50	002.10000178.00	Telescopic leg with 2x M10 bolt	380mm - 500mm
K002.ZV45-63	002.10000179.00	Telescopic leg with 2x M10 bolt	450mm - 630mm
K002.ZV63-100	002.10000180.00	Telescopic leg with 2x M10 bolt	630mm - 1000mm
K002.ZV84-140	002.10000181.00	Telescopic leg with 2x M10 bolt	840mm - 1400mm

### Attention:

All numbers about the length of a leg or the height of a platform refer to the total height of the platform applying our 21mm plywood board with a 3mm felt layer between the frame and the board.

## Single telescopic leg accessories

Order code	Item no.	Description
K002.ZK50	002.10000121.00	Plastic plug 50mm x 50mm
K002.ZK48X3	002.10000119.00	Plastic plug Ø48mm
K002.ZKV48	002.10000104.00	Plastic plug with M12 thread Ø48mm, load 1200Kg
K002.ZKV50	002.10000105.00	Plastic plug with M12 thread, 50mm x 50mm, 1200Kg
K002.ZKV60	002.10000106.00	Plastic plug with M12 thread, 60mm x 60mm, 1200Kg
K002.ZN80	002.10000103.00	Adjusting screw M12 with plastic base, load 1200Kg, ± 35 mm
K002.ZFV50	002.10000099.00	Leg connector Ø48mm and 50x50mm
K002.ZFV60	002.10000102.00	Leg connector 60mm x 60mm
K002.ZEB	002.10000061.00	Eccentric bolt with R-Clip

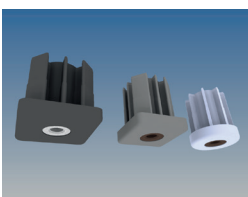

K002.ZKV60/50/48

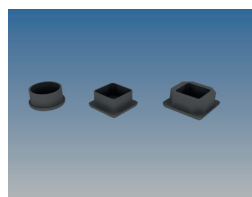

K002.ZK48X3 / ZK50

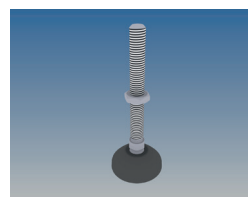

K002.ZN80

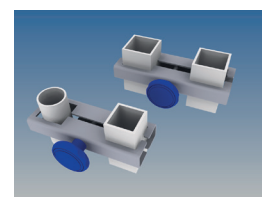

K002.ZFV60

**Attention:**

All numbers about the length of a leg or the height of a platform refer to the total height of the platform applying our 21mm plywood board with a 3mm felt layer between the frame and the board.

## Telescopic V-frames with eccentric bolts

Order code	Item no.	Description	Length
K002.ZVF40	002.10000190.00	Telescopic V-frame 40/45	400mm - 450mm
K002.ZVF45	002.10000191.00	Telescopic V-frame 45/50	450mm - 500mm
K002.ZVF50	002.10000193.00	Telescopic V-frame 50/65	500mm - 650mm
K002.ZVF60	002.10000195.00	Telescopic V-frame 60/85	600mm - 850mm
K002.ZVF80	002.10000197.00	Telescopic V-frame 80/120	800mm - 1200mm
K002.ZVF100	002.10000185.00	Telescopic V-frame 100/160	1000mm - 1600mm
K002.ZVF150	002.10000186.00	Telescopic V-frame 150/235	1500mm - 2350mm
K002.ZVF200	002.10000187.00	Telescopic V-frame 200/285	2000mm - 2850mm
K002.ZVF250	002.10000188.00	Telescopic V-frame 250/335	2500mm - 3350mm
K002.ZVF300	002.10000189.00	Telescopic V-frame 300/385	3000mm - 3850mm

## V-frame accessories

Order code	Item no.	Description
K002.ZVR1	002.10000125.00	Set of Doughty coupler with adjusting leg M12 and connection bar
K002.ZVR2	002.10000124.00	Set of Doughty coupler with adjusting leg M12
K002.ZVC	002.10000001.00	1m connection bar with 2 bolts M10
K002.ZKV50	002.10000105.00	Plastic plug with M12 thread, 50x50mm, load 750Kg
K002.ZKV60	002.10000106.00	Plastic plug with M12 thread, 60x60mm, load 750Kg
K002.ZN80	002.10000103.00	Adjusting screw M12 with plastic base, load 1200Kg, ± 35mm
K002.ZFV60	002.10000102.00	Leg connector 60x60mm
K002.ZEB	002.10000061.00	Eccentric bolt with R-Clip



K002.ZVC

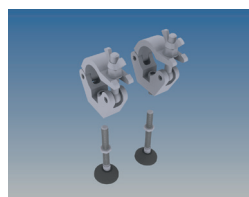

K002.ZVR2

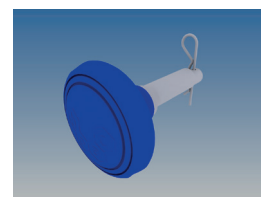

K002.ZEB



## Telescopic V-frame bottom part

Order code	Item no.	Description	min. length stage top
K002.ZVFB40	002.10000204.00	V-frame bottom part 40/45	400mm
K002.ZVFB50	002.10000205.00	V-frame bottom part 50	500mm
K002.ZVFB60	002.10000206.00	V-frame bottom part 60	600mm
K002.ZVFB80	002.10000207.00	V-frame bottom part 80	800mm
K002.ZVFB100	002.10000198.00	V-frame bottom part 100	1000mm
K002.ZVFB150	002.10000199.00	V-frame bottom part 150	1500mm
K002.ZVFB200	002.10000200.00	V-frame bottom part 200	2000mm
K002.ZVFB250	002.10000201.00	V-frame bottom part 250	2500mm
K002.ZVFB300	002.10000202.00	V-frame bottom part 300	3000mm

## Telescopic V-frame top part

Order code	Item no.	Description	range adjustable 0-
K002.ZTLT5	002.10000009.00	Single leg / V-frame top part 5	50mm
K002.ZTLT10	002.10000005.00	Single leg / V-frame top part 10	100mm
K002.ZTLT15	002.10000006.00	Single leg / V-frame top part 15	150mm
K002.ZTLT25	002.10000007.00	Single leg / V-frame top part 25	250mm
K002.ZTLT40	002.10000008.00	Single leg / V-frame top part 40	400mm
K002.ZTLT60	002.10000010.00	Single leg / V-frame top part 60	600mm
K002.ZTLT85	002.10000011.00	Single leg / V-frame top part 85	850mm

You need 2 top parts per bottom part.

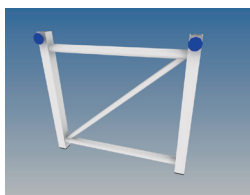

K002.ZVFB

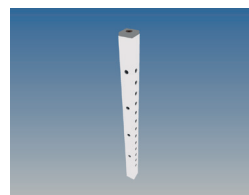

K002.ZTLT



## Bracings for V-frames

Order code	Item no.	Description
K002.HR868	002.10000116.00	Horizontal bracing 868
K002.HR1000	002.10000110.00	Horizontal bracing 1000
K002.HR1132	002.10000111.00	Horizontal bracing 1132
K002.HR1868	002.10000112.00	Horizontal bracing 1868
K002.HR2000	002.10000113.00	Horizontal bracing 2000
K002.HR2132	002.10000114.00	Horizontal bracing 2132
K002.HR2868	002.10000115.00	Horizontal bracing 2868
K002.DR666	002.10000018.00	Diagonal bracing 666
K002.DR1000	002.10000016.00	Diagonal bracing 1000
K002.DR1333	002.10000017.00	Diagonal bracing 1333

## Bracings for V-frames raked stage

Order code	Item no.	Description	Length
K002.RV140	002.10000182.00	Bracing vario 140	1400mm - 2350mm
K002.RV190	002.10001219.00	Bracing vario 190	1900mm - 3350mm
K002.RV220	002.10000184.00	Bracing vario 220	2200mm - 3950mm

## Wheel mover for all V-frames

Order code	Item no.	Description	leg distance
K002.VRR100	002.10000107.00	Wheel mover 100	868mm - 1132mm
K002.VRR200	002.10000108.00	Wheel mover 200	1868mm - 2868mm
K002.VRR300	002.10000109.00	Wheel mover 300	2868mm - 3132mm

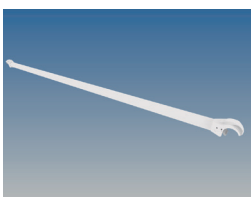

K002.HR2000

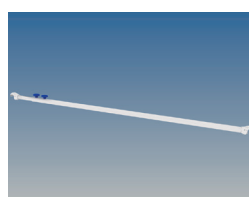

K002.RV190

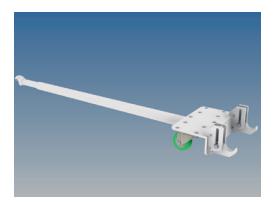

K002.VRR200

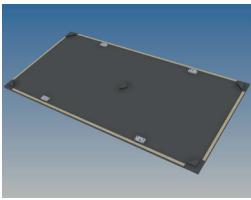

### Deck plywood birch black 21mm with locks and corner protection

Order code	Item no.	Description	Length	Width
K002.MP21-2/1KV	002.10000049.00	Deck plywood 21mm, black, with locks, 3x20mm felt and corner protection	2000mm	1000mm
K002.MP21-1/1KV	002.10000050.00	Deck plywood 21mm, black, with locks, 3x20mm felt and corner protection	1000mm	1000mm
K002.MP21-2/0KV	002.10000047.00	Deck plywood 21mm, black, with locks, 3x20mm felt and corner protection	2000mm	500mm
K002.MP21-1/0KV	002.10000048.00	Deck plywood 21mm, black, with locks, 3x20mm felt and corner protection	1000mm	500mm

### Deck plywood birch black 27mm with locks and corner protection

Order code	Item no.	Description	Length	Width
K002.MP27-2/1KV	002.10000051.00	Deck plywood 27mm, black, with locks, 3x20mm felt and corner protection	2000mm	1000mm
K002.MP27-1/1KV	002.10000052.00	Deck plywood 27mm, black, with locks, 3x20mm felt and corner protection	1000mm	1000mm
K002.MP27-2/0KV	002.10000053.00	Deck plywood 27mm, black, with locks, 3x20mm felt and corner protection	2000mm	500mm
K002.MP27-1/0KV	002.10000054.00	Deck plywood 27mm, black, with locks, 3x20mm felt and corner protection	1000mm	500mm

### Deck plywood birch outdoor 21mm with locks and corner protection

Order code	Item no.	Description	Length	Width
K002.SD21-2/1KV	002.10000055.00	Deck plywood 21mm, outdoor, with locks, 3x20mm felt and corner protection	2000mm	1000mm
K002.SD21-1/1KV	002.10000056.00	Deck plywood 21mm, outdoor, with locks, 3x20mm felt and corner protection	1000mm	1000mm
K002.SD21-2/0KV	002.10000057.00	Deck plywood 21mm, outdoor, with locks, 3x20mm felt and corner protection	2000mm	500mm
K002.SD21-1/0KV	002.10000058.00	Deck plywood 21mm, outdoor, with locks, 3x20mm felt and corner protection	1000mm	500mm

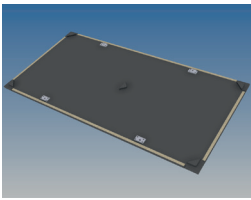

## Deck plywood birch black 21mm with locks for triangular frames

Order code	Item no.	Description	Length	Width
K002.MP21-1/1EV	002.10000046.00	Deck plywood 21mm, black, with locks and 3x20mm felt	1000mm	1000mm
K002.MP21-2/1EVR	002.10000045.00	Deck plywood 21mm, black, with locks and 3x20mm felt	2000mm	1000mm
K002.MP21-2/1EVL	002.10000041.00	Deck plywood 21mm, black, with locks and 3x20mm felt	2000mm	1000mm

Add the L or R behind the order code for the left and right triangular frame.

## Deck accessories

Order code	Item no.	Description
K002.V/H	002.10000123.00	Single lock
K002.V/H4	002.10001299.00	Single lock set 4 pieces incl. screws
K002.V/H20	002.10001300.00	Single lock set 20 pieces incl. screws
K002.V/H40	002.10001301.00	Single lock set 40 pieces incl. screws
K002.V/HS	002.10000117.00	Hexagon key for lock
K002.KS/H21	002.10000126.00	4x 21mm corner protection + 1x center block
K002.KS/H24	002.10000127.00	4x 24mm corner protection + 1x center block
K002.KS/H27	002.10000128.00	4x 27mm corner protection + 1x center block
K002.ZK/H	002.10000129.00	5x center block

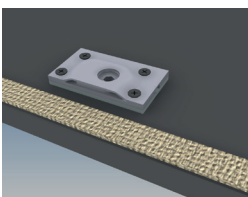

K002.V/H

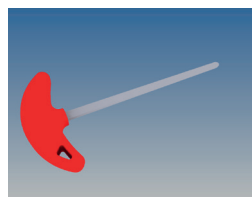

K002.V/HS

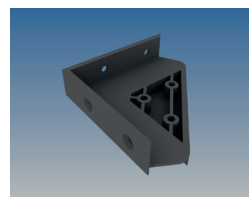

K002.KS/H21

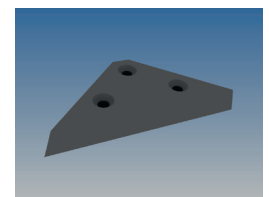

K002.ZK/H



### Safety railings for system frame 16<sup>2</sup>/<sub>3</sub> or 20

Order code	Item no. (-16)	Description
K002.SG1.2-16 o. -20	002.10000486.00	Safety railing black powder coated 1.2m wide
K002.SG1.1-16 o. -20	002.10001090.00	Safety railing black powder coated 1.1m wide
K002.SG1-16 o. -20	002.10000249.00	Safety railing black powder coated 1.0m wide
K002.SG0.9-16 o. -20	002.10000308.00	Safety railing black powder coated 0.9m wide
K002.SG0.8-16 o. -20	002.10000306.00	Safety railing black powder coated 0.8m wide
K002.SG0.7-16 o. -20	002.10000489.00	Safety railing black powder coated 0.7m wide
K002.SG0.6-16 o. -20	002.10001067.00	Safety railing black powder coated 0.6m wide
K002.SG0-16 o. -20	002.10000130.00	Safety railing black powder coated 0.5m wide

### Stage railings for system frame 16<sup>2</sup>/<sub>3</sub> or 20

Order code	Item no. (-16)	Description
K002.BG1.2-16 o. -20	002.10000348.00	Stage railing black powder coated 1.2m wide
K002.BG1.1-16 o. -20	002.20000740.00	Stage railing black powder coated 1.1m wide
K002.BG1-16 o. -20	002.10000013.00	Stage railing black powder coated 1.0m wide
K002.BG0.9-16 o. -20	002.10000309.00	Stage railing black powder coated 0.9m wide
K002.BG0.8-16 o. -20	002.10000354.00	Stage railing black powder coated 0.8m wide
K002.BG0.7-16 o. -20	002.10001163.00	Stage railing black powder coated 0.7m wide
K002.BG0.6-16 o. -20	002.10000983.00	Stage railing black powder coated 0.6m wide
K002.BG0-16 o. -20	002.10000012.00	Stage railing black powder coated 0.5m wide



K002.SG1-16



K002.BG1-16

The railing is fastened without tools by means of a click mechanism.  
 On request, railings can be manufactured screwable or pluggable.



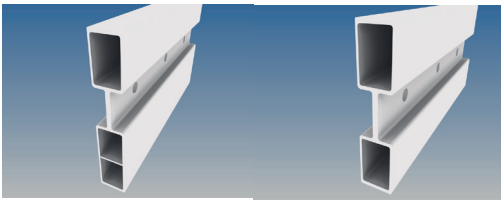

### System frame 16<sup>2/3</sup> and 20 - technical data

System	Profile height [mm]	Profile width [mm]	Material	Cross sectional area [cm <sup>2</sup> ]	Weight [Kg/m]
16 <sup>2/3</sup> Profile	140,00	30,00	ENAW6063T66	9,27	2,82
20 Profile	173,00	30,00	ENAW6063T66	11,15	3,20

System	Moment of inertia [l/cm <sup>4</sup> ]	Moment of resistance [W/cm <sup>3</sup> ]	Line load per. [kN/m], free span 2m	Point load per. [kN/m], free span 2m
16 <sup>2/3</sup> Profile	184,93	26,42	5,54	5,54
20 Profile	328,68	37,80	7,94	7,94

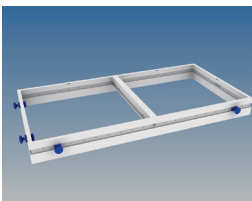

### Permitted distribution load [kN/m<sup>2</sup>] with cross bar

System	System frame 2m x 1m 2m free span [kN/m <sup>2</sup> ]	System frame 3m x 1m 3m free span [kN/m <sup>2</sup> ]	System frame 4m x 1m 4m free span [kN/m <sup>2</sup> ]
16 <sup>2/3</sup>	8,68	3,94	2,09
20	12,49	5,71	3,04

### Permitted distribution load [kN/m<sup>2</sup>] without cross bar

System	System frame 2m x 1m 2m free span [kN/m <sup>2</sup> ]	System frame 3m x 1m 3m free span [kN/m <sup>2</sup> ]	System frame 4m x 1m 4m free span [kN/m <sup>2</sup> ]
16 <sup>2/3</sup>	10,94	4,78	2,63
20	15,74	6,92	3,83

## 3. HOAC<sup>®</sup> TURNTABLES

- 3.1 Turntable Ø 5m - Ø 22m
- 3.2 Turntable rings
- 3.3 Turntable technical data
- 3.4 Turntable... more options
- 3.5 Turntable center parts
- 3.6 Turntable motors
- 3.7 Turntable control

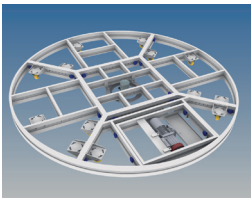

### Turntable incl. aluminium frames, wheels and plywood decks 21mm, black

Order code	Item no.	Description	Diameter
K003.DR5000	003.10000353.00	Turntable 5m incl. aluminium frames, wheels	5000mm
K003.DR6000	003.10000355.00	Turntable 6m incl. aluminium frames, wheels	6000mm
K003.DR7000	003.10000357.00	Turntable 7m incl. aluminium frames, wheels	7000mm
K003.DR8000	003.10000359.00	Turntable 8m incl. aluminium frames, wheels	8000mm
K003.DR9000	003.10000361.00	Turntable 9m incl. aluminium frames, wheels	9000mm
K003.DR10000	003.10000322.00	Turntable 10m incl. aluminium frames, wheels	10000mm
K003.DR11000	003.10000325.00	Turntable 11m incl. aluminium frames, wheels	11000mm
K003.DR12000	003.10000327.00	Turntable 12m incl. aluminium frames, wheels	12000mm
K003.DR13000	003.10000329.00	Turntable 13m incl. aluminium frames, wheels	13000mm
K003.DR14000	003.10000331.00	Turntable 14m incl. aluminium frames, wheels	14000mm
K003.DR15000	003.10000333.00	Turntable 15m incl. aluminium frames, wheels	15000mm
K003.DR16000	003.10000335.00	Turntable 16m incl. aluminium frames, wheels	16000mm
K003.DR17000	003.10000337.00	Turntable 17m incl. aluminium frames, wheels	17000mm
K003.DR18000	003.10000339.00	Turntable 18m incl. aluminium frames, wheels	18000mm
K003.DR19000	003.10000341.00	Turntable 19m incl. aluminium frames, wheels	19000mm
K003.DR20000	003.10000343.00	Turntable 20m incl. aluminium frames, wheels	20000mm
K003.DR21000	003.10000345.00	Turntable 21m incl. aluminium frames, wheels	21000mm
K003.DR22000	003.10000347.00	Turntable 22m incl. aluminium frames, wheels	22000mm

- All turntables are divided into 8 sections, splitted into single frames, maximum size 1.5m x 3m.
- All frames are welded according to the european standard 1090-3.
- The standard height of the turntable with decks is 200mm.
- For 166mm height, add -16 to the order code. The price will be the same.
- Standard static load is 500Kg/m<sup>2</sup>
- Dynamic load can be 250Kg/m<sup>2</sup>, but is limited by the number and type of used motors.
- The plywood boards are black painted and they have locks
- 3mm felt layer under the board prevents sound transmission

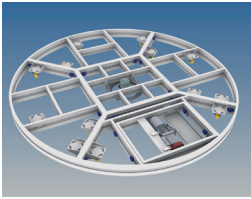

Extension rings incl. aluminium frames, wheels and plywood decks 21mm, black

Order code	Item no.	Description
K003.DRR-A	003.10000319.00	Turntable ring A incl. aluminium frames and wheels
K003.DRR-B	003.10000320.00	Turntable ring B incl. aluminium frames and wheels
K003.DRR-C	003.10000366.00	Turntable ring C incl. aluminium frames and wheels
K003.DRR-D	003.10000367.00	Turntable ring D incl. aluminium frames and wheels
K003.DRR-E	003.10000368.00	Turntable ring E incl. aluminium frames and wheels
K003.DRR-F	003.10000369.00	Turntable ring F incl. aluminium frames and wheels
K003.DRR-G	003.10000370.00	Turntable ring G incl. aluminium frames and wheels
K003.DRR-H	003.10000371.00	Turntable ring H incl. aluminium frames and wheels
K003.DRR-I	003.10000372.00	Turntable ring I incl. aluminium frames and wheels
K003.DRA5000	003.10000375.00	Turntable ring 5m incl. aluminium frames and wheels
K003.DRA6000	003.10000376.00	Turntable ring 6m incl. aluminium frames and wheels
K003.DRA7000	003.10000377.00	Turntable ring 7m incl. aluminium frames and wheels
K003.DRA8000	003.10000321.00	Turntable ring 8m incl. aluminium frames and wheels
K003.DRA9000	003.10000379.00	Turntable ring 9m incl. aluminium frames and wheels
K003.DRA10000	003.10000380.00	Turntable ring 10m incl. aluminium frames and wheels
K003.DRA11000	003.10000381.00	Turntable ring 11m incl. aluminium frames and wheels
K003.DRA12000	003.10000382.00	Turntable ring 12m incl. aluminium frames and wheels
K003.DRA13000	003.10000384.00	Turntable ring 13m incl. aluminium frames and wheels
K003.DRA14000	003.10000385.00	Turntable ring 14m incl. aluminium frames and wheels
K003.DRA15000	003.10000386.00	Turntable ring 15m incl. aluminium frames and wheels
K003.DRA16000	003.10000397.00	Turntable ring 16m incl. aluminium frames and wheels
K003.DRA17000	003.10000387.00	Turntable ring 17m incl. aluminium frames and wheels
K003.DRA18000	003.10000388.00	Turntable ring 18m incl. aluminium frames and wheels
K003.DRA19000	003.10000389.00	Turntable ring 19m incl. aluminium frames and wheels
K003.DRA20000	003.10000390.00	Turntable ring 20m incl. aluminium frames and wheels
K003.DRA21000	003.10000391.00	Turntable ring 21m incl. aluminium frames and wheels
K003.DRA22000	003.10000392.00	Turntable ring 22m incl. aluminium frames and wheels

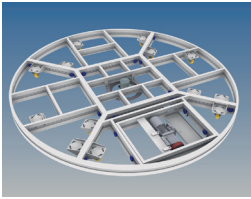

### Turntable technical information

Ø m	total surface m <sup>2</sup>	frames total number pcs.	total load dynamic 250Kg/m <sup>2</sup>	extension rings used	recommended motor units total number	max. load dynamic
5m	19,6	8	4900 Kg		4	8000 Kg
6m	28,2	16	7050 Kg	A	4	8000 Kg
7m	38,5	16	9625 Kg	A + B	4	8000 Kg
8m	50,2	40	12559 Kg	A + B	4	8000 Kg
9m	63,6	40	15900 Kg	A + B + C	4	8000 Kg
10m	78,5	56	19625 Kg	A + B + C	4	8000 Kg
11m	95,0	56	23775 Kg	A + B + C + D	6	12000 Kg
12m	113,1	80	28275 Kg	A + B + C + D	6	12000 Kg
13m	132,7	80	32750 Kg	A+B+C+D+E	6	12000 Kg
14m	153,9	112	38150 Kg	A+B+C+D+E	6	12000 Kg
15m	176,7	112	44225 Kg	A+B+C+D+E+F	8	16000 Kg
16m	201,0	136	50250 Kg	A+B+C+D+E+F	8	16000 Kg
17m	227,0	136	56250 Kg	A - G	8	16000 Kg
18m	254,5	160	63500 Kg	A - G	8	16000 Kg
19m	283,5	160	70250 Kg	A - H	8	16000 Kg
20m	314,2	200	78500 Kg	A - H	8	16000 Kg
21m	346,4	200	86500 Kg	A - I	8	16000 Kg
22m	380,1	200	94200 Kg	A - I	8	16000 Kg

- The dynamic load is based on a 0,75kW standard motor unit.
- The number of motors is just a recommendation that we would use in a standard quote.
- Dynamic load changeable by using more or different motor types.

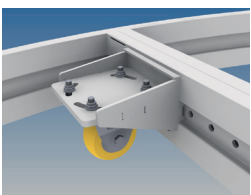

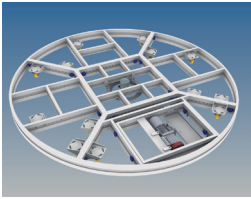
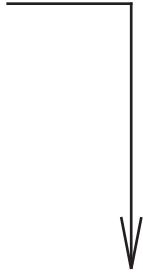
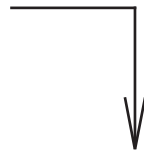
**HOAC**<sup>®</sup> Turntable without decks 21mm - price deduction

**HOAC**<sup>®</sup> Decks for turntable  
square surrounding  
incl. decks, legholder  
and 20cm legs

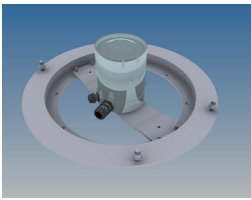
Ø m	Order code	€/pcs.	Order code	Item no.	Size m x m
5m	K003.DG1-5	-3.616,00	K003.UG2-5	003.10000352.00	6m x 6m
6m	K003.DG1-6	-4.256,00	K003.UG2-6	003.10000354.00	7m x 7m
7m	K003.DG1-7	-7.872,00	K003.UG2-7	003.10000356.00	8m x 8m
8m	K003.DG1-8	-8.512,00	K003.UG2-8	003.10000358.00	9m x 9m
9m	K003.DG1-9	-12.768,00	K003.UG2-9	003.10000360.00	10m x 10m
10m	K003.DG1-10	-12.768,00	K003.UG2-10	003.10000323.00	11m x 11m
11m	K003.DG1-11	-17.024,00	K003.UG2-11	003.10000324.00	12m x 12m
12m	K003.DG1-12	-22.979,00	K003.UG2-12	003.10000326.00	13m x 13m
13m	K003.DG1-13	-30.211,00	K003.UG2-13	003.10000328.00	14m x 14m
14m	K003.DG1-14	-33.190,00	K003.UG2-14	003.10000330.00	15m x 15m
15m	K003.DG1-15	-40.422,00	K003.UG2-15	003.10000332.00	16m x 16m
16m	K003.DG1-16	-41.702,00	K003.UG2-16	003.10000334.00	17m x 17m
17m	K003.DG1-17	-50.214,00	K003.UG2-17	003.10000336.00	18m x 18m
18m	K003.DG1-18	-50.214,00	K003.UG2-18	003.10000338.00	19m x 19m
19m	K003.DG1-19	-58.726,00	K003.UG2-19	003.10000340.00	20m x 20m
20m	K003.DG1-20	-58.726,00	K003.UG2-20	003.10000342.00	21m x 21m
21m	K003.DG1-21	-67.238,00	K003.UG2-21	003.10000344.00	22m x 22m
22m	K003.DG1-22	-67.238,00	K003.UG2-22	003.10000346.00	23m x 23m



## Turntable center bearing plus sliprings

Order code	Item no.	Description
K003.DRZ40	003.10000364.00	Center bearing passive four-sided
K003.DRZ80	003.10000362.00	Center bearing passive eight-sided
K003.DRZ80/2-8A	003.10000402.00	Center bearing with slipring otor plus 10 additional rings 5x 32 Amp.
K003.DRZ80E	003.10000317.00	Center bearing with slipring motor and 1x 16 Amp.

- Ask for different rings like power, audio, DMX fiber optics.
- For control system advanced the slipring for data has to be in the center bearing passive.
- To connect the cable to the slipring there needs to be a hadge in the floor.
- Without a hadge for the cable connection a double layer floor is an option.

## Motor unit options and accessories

Order code	Item no.	Description
K003.DRIS02	003.10000115.00	Aufpreis für Motorschutzschalter
K003.DRMC3	003.10000111.00	Motorkabel Länge 3m
K003.DRMC5	003.10000112.00	Motorkabel Länge 5m
K003.DRMC7	003.10000113.00	Motorkabel Länge 7m
K003.DRMC9	003.10000114.00	Motorkabel Länge 9m
K003.DRMC11	003.10000110.00	Motorkabel Länge 11m

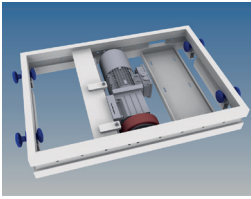

### Motor unit standard with brake

Order code	Item no.	Description	Ø / wheel
K003.DRI1	003.10000107.00	Motor unit friction drive in 1m x 1m frame, 0,75 kW with a maximum speed of 0.8m/sec.	180mm
K003.DRI2	003.10000104.00	Motor unit friction drive in 1m x 1m frame, 0,75 kW with a maximum speed of 0.8m/sec.	180mm
K003.DRI3	003.10000101.00	Motor unit friction drive in 1m x 1m frame, 0,6 kW with a maximum speed of 0.3m/sec.	120mm

- The motor 03.DRI3 with the 120mm drive wheel can be used for 166mm high turntables.

### Upgrade for motor unit standard with incremental encoder

Order code	Description
K003.XXXX + G	Additional incremental encoder in motor unit, for Advanced control

### Upgrade for motor unit with mechanic to lift up the drive wheel

Order code	Description
K003.XXXX + LR	Motor unit with mechanic to lift up the drive wheel. The plywood deck needs to be lifted up for this.

### Upgrade motor unit with mechanic to adjust the drive direction 360°

Order code	Description
K003.XXXX + D	Motor unit with mechanic to lift up the drive wheel and to adjust the drive direction 360°. The plywood deck needs to be lifted up for this. Simple adjustment by 5° marks on the ring.



### Turntable control system standard

Order code	Item no.	Description	Number motor units
K003.DRIC4	003.10000121.00	Motor control 4kW for 4 motors 0.75kW, hand held control with 15m cable.	4
K003.DRIC6		Motor control 5.5kW for 6 motors 0.75kW, hand held control with 15m cable.	6
K003.DRIC8	003.10000123.00	Motor control 7.5kW for 8 motors 0.75kW, hand held control with 15m cable.	8

### Turntable control system advanced

Order code	Item no.	Description	Number motor units
K003.DRIC4A	003.10000124.00	Motor control 4kW for 4 motors 0.75kW, hand held control with 15m cable, 15 positions available.	4
K003.DRIC6A		Motor control 5.5kW for 6 motors 0.75kW, hand held control with 15m cable, 15 positions available.	6
K003.DRIC8A	003.10000126.00	Motor control 7.5kW for 8 motors 0.75kW, hand held control with 15m cable, 15 positions available.	8

For other options regarding control, ask us...

## 4. **HOAC**<sup>®</sup> STAGE WAGON

- 4.1 Stage wagon and system frames with wire openings
- 4.2 Stage wagon frames and profiles
- 4.3 Wheels and Stage wagon accessories
- 4.4 Up2Move units and control
- 4.5 Stage wagon decks
- 4.T Technical data

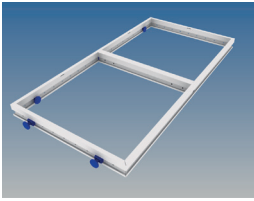

### Stage wagon frame for wagon height 16<sup>2</sup>/<sub>3</sub> and 20, with wire openings

Order code	Length	Width	Cross bars	Link blocks	Wire openings
K004.Z1/1-BWC	1000mm	1000mm	0	4	8
K004.Z2/1-BWC	2000mm	1000mm	1	4	14
K004.Z3/1-BWC	3000mm	1000mm	2	5	20
K004.Z4/1-BWC	4000mm	1000mm	3	6	26
K004.Z0/0-BWC	500mm	500mm	0	2	4
K004.Z1/0-BWC	1000mm	500mm	0	3	6
K004.Z2/0-BWC	2000mm	500mm	1	3	11
K004.Z3/0-BWC	3000mm	500mm	2	4	16
K004.Z4/0-BWC	4000mm	500mm	3	5	21

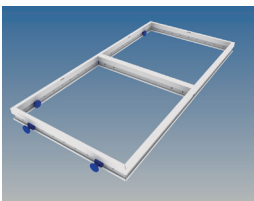

### System frame 16<sup>2</sup>/<sub>3</sub> for wagon height 20, with wire openings

Order code	Length	Width	Cross bars	Link blocks	Wire openings
K004.Z1/1-BWC	1000mm	1000mm	0	4	8
K004.Z2/1-BWC	2000mm	1000mm	1	4	14
K004.Z3/1-BWC	3000mm	1000mm	2	5	20
K004.Z4/1-BWC	4000mm	1000mm	3	6	26
K004.Z0/0-BWC	500mm	500mm	0	2	4
K004.Z1/0-BWC	1000mm	500mm	0	3	6
K004.Z2/0-BWC	2000mm	500mm	1	3	11
K004.Z3/0-BWC	3000mm	500mm	2	4	16
K004.Z4/0-BWC	4000mm	500mm	3	5	21

All frames come with a full set of link blocks and cross bars.  
 Beside the standard we also manufacture different sizes and shapes.  
 Powder coating in any RAL or NTSC code is possible.

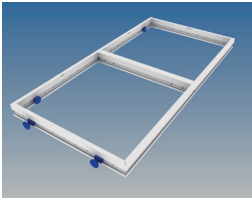

## Stage wagon frame for wagon height 16<sup>2</sup>/<sub>3</sub> and 20

Order code	Item no.	Length	Width	Cross bars	Link blocks
K004.Z1/1-BW	004.20000002.00	1000mm	1000mm	0	4
K004.Z2/1-BW	004.20000001.00	2000mm	1000mm	1	4
K004.Z3/1-BW	004.20000003.00	3000mm	1000mm	2	5
K004.Z4/1-BW	004.20000004.00	4000mm	1000mm	3	6
K004.Z0/0-BW	004.20000010.00	500mm	500mm	0	2
K004.Z1/0-BW	004.20000005.00	1000mm	500mm	0	3
K004.Z2/0-BW	004.20000006.00	2000mm	500mm	1	3
K004.Z3/0-BW	004.20000007.00	3000mm	500mm	2	4
K004.Z4/0-BW	004.20000008.00	4000mm	500mm	3	5

All frames come with a full set of link blocks and cross bars.  
 Beside the standard we manufacture also different sizes and shapes.  
 Powder coating in any RAL or NTSC code is possible.

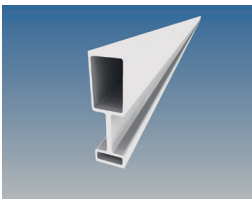

## Stage wagon profiles for wagon height 16<sup>2</sup>/<sub>3</sub> and 20

Order code	Item no.	Description	Length
K004.BWZ-6	110.10000136.00	Stage wagon profile	6055mm
K004.BWZ-G6	004.20000000.00	Stage wagon profile, incl. 12mm holes	6055mm

00.CB	Cost for bending 6m length (min. radius 1000)
00.CC	Cost for each cut (45°- 90°)

Selling of profiles only in length of 6m. We offer cutting from 90° to 45°. Oddment enclosed.

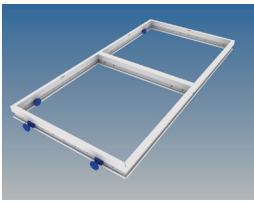

### Stage wagon frame accessories

Order code	Item no.	Description	Overall height
K004.BWZ01	004.10000124.00	Wheel base plate for frame installation	200mm
K004.BWZ02	004.10000125.00	Wheel base plate for legholder installation	240mm
K004.BWZ03	004.10000018.00	Adapter plate for triple castor 50mm	200mm
K004.BWZB80	004.10000016.00	Wheel bridge triple castor 80mm, 0.5m	200mm

### Stage wagon frame wheels

Order code	Item no.	Description	Load
K004.BR100VV	570.10000010.00	Fixed castor 100mm for BWZ01/BWZ02	350Kg
K004.LR100VV	570.10000001.00	Castor 100mm for BWZ01/BWZ02	350Kg
K004.LRD100VV	570.10000006.00	Castor with double wheel 100mm for BWZ01/BWZ02	350Kg
K004.LRD80VV	570.10000016.00	Castor with double wheel 80mm heavy duty for BWZ01/BWZ02	600Kg
K004.TC50	004.10000023.00	Turtle castor 50mm for BWZ01 with BWZ03	350Kg
K004.TC80	004.10000024.00	Turtle castor 80mm for bridge 80	400Kg
K004.TC80S1	004.10000036.00	Turtle castor with double wheel 80mm heavy duty, construction height = 166	1000Kg
K004.TC80S3	004.10000122.00	Turtle castor with double wheel 80mm heavy duty, construction height = 130	750Kg
K004.TC100	004.10000022.00	Turtle castor 100mm for bridge 100	750Kg

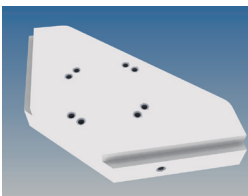

K004.BWZ01

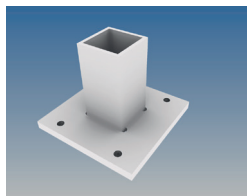

K004.BWZ02

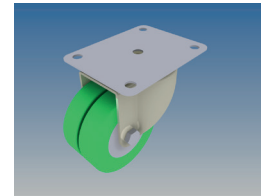

K004.LRD100VV

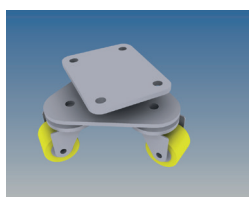

K004.TC50

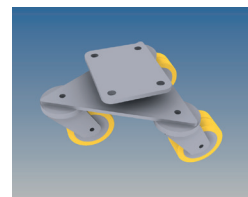

K004.TC80

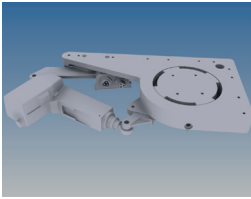

## Up2Move

Order code	Item no.	Description
K004.UP2E35	004.10000156.00	Up2Move, electrical, 35mm lifting range, 250Kg lifting capacity
K004.UP2HZ35	004.10000153.00	Up2Move wheel holder for HOAC system frame use
K004.UP2HA	004.10000025.00	Up2Move aluminium wheel holder, for welding in external constructions
K004.UP2HS	004.10000026.00	Up2Move steel wheel holder, for welding in external constructions

## Connection cables

Order code	Item no.	Description	Length
K004.UP2K1	004.10000031.00	Connection cable Up2Move	1m
K004.UP2K2	004.10000032.00	Connection cable Up2Move	2m
K004.UP2K3	004.10000033.00	Connection cable Up2Move	3m
K004.UP2K5	004.10000034.00	Connection cable Up2Move	5m
K004.UP2K10	004.10000030.00	Connection cable Up2Move	10m
K004.ZKH	004.10000013.00	Cable bracket for system frame use	

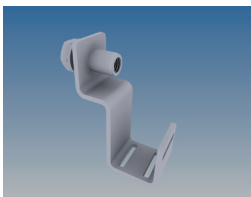

K004.ZKH

## Control

Order code	Item no.	Description
K004.UP2ST	004.10000020.00	Control case for 20 units, connector 220V, incl. switch box to connect control to the units.
K004.UP2STF1	004.10000182.00	Control for 10 units, battery driven, built in a system frame 1m x 1m. Battery can be taken out from the side. Up/down with radio control.
K004.UP2STF2	004.10000183.00	Like model UP2STF1, but in a frame 2m x 1m, 4 Up2Move units may be added.

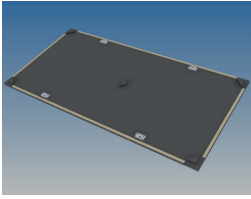

### Deck plywood birch black 21mm with locks and corner protection

Order code	Item no.	Description	Length	Width
K002.MP21-2/1KV	002.10000049.00	Deck plywood 21mm, black, with locks, 3x20mm felt and corner protection	2000mm	1000mm
K002.MP21-1/1KV	002.10000050.00	Deck plywood 21mm, black, with locks, 3x20mm felt and corner protection	1000mm	1000mm
K002.MP21-2/0KV	002.10000047.00	Deck plywood 21mm, black, with locks, 3x20mm felt and corner protection	2000mm	500mm
K002.MP21-1/0KV	002.10000048.00	Deck plywood 21mm, black, with locks, 3x20mm felt and corner protection	1000mm	500mm

### Deck plywood birch black 27mm with locks and corner protection

Order code	Item no.	Description	Length	Width
K002.MP27-2/1KV	002.10000051.00	Deck plywood 27mm, black, with locks, 3x20mm felt and corner protection	2000mm	1000mm
K002.MP27-1/1KV	002.10000052.00	Deck plywood 27mm, black, with locks, 3x20mm felt and corner protection	1000mm	1000mm
K002.MP27-2/0KV	002.10000053.00	Deck plywood 27mm, black, with locks, 3x20mm felt and corner protection	2000mm	500mm
K002.MP27-1/0KV	002.10000054.00	Deck plywood 27mm, black, with locks, 3x20mm felt and corner protection	1000mm	500mm

### Deck accessories

Order code	Item no.	Description
K002.V/HS	002.10000117.00	Hexagon key for locks

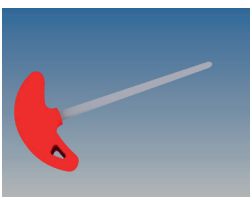

K002.V/HS

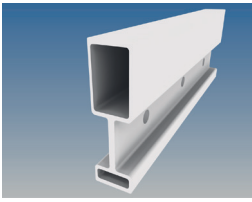

### Stage wagon profile - Technical data

System	Profile height [mm]	Profile width [mm]	Material	Cross sectional area [cm <sup>2</sup> ]	Weight [Kg/m]
Stage wagon Profile	105,00	30,00	ENAW6063T66	7,88	2,34

System	Moment of inertia [l/cm <sup>4</sup> ]	Moment of resistance [W/cm <sup>3</sup> ]	Line load per. [kN/m], free span 2m	Point load per. [kN/m], free span 2m
Stage wagon Profile	97,95	17,31	3,64	3,64

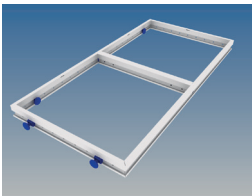

### Permitted distribution load [kN/m<sup>2</sup>] with cross bar

System	System frame 2m x 1m 2m free span [kN/m <sup>2</sup> ]	System frame 3m x 1m 2m free span [kN/m <sup>2</sup> ]	System frame 4m x 1m 2m free span [kN/m <sup>2</sup> ]
Stage wagon frame	5,67	2,55	1,33

### Permitted distribution load [kN/m<sup>2</sup>] without cross bar

System	System frame 2m x 1m 2m free span [kN/m <sup>2</sup> ]	System frame 3m x 1m 2m free span [kN/m <sup>2</sup> ]	System frame 4m x 1m 2m free span [kN/m <sup>2</sup> ]
Stage wagon frame	7,14	3,10	1,68



## 5. **HOAC**<sup>®</sup> GRANDSTAND

- 5.1 System frames and accessories
- 5.2 V-frame System 16 <sup>2</sup>/<sub>3</sub>
- 5.3 V-frame System 9/18
- 5.4 V-frame System 20
- 5.5 V-frame System 25
- 5.6 Grandstand accessories
- 5.7 Telescopic Riser System 20
- 5.8 Telescopic Riser System 33

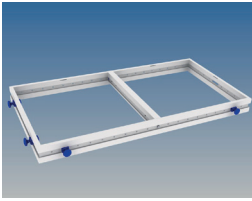

### System frame 16<sup>2</sup>/<sub>3</sub> with link blocks and cross bars

Order code	Item no.	Length	Width	Cross bars	Link blocks
K002.Z1/1-16	002.10001091.00	1000mm	1000mm	0	4
K002.Z2/1-16	002.10001052.00	2000mm	1000mm	1	4
K002.Z3/1-16	002.10001092.00	3000mm	1000mm	2	5
K002.Z4/1-16	002.10001093.00	4000mm	1000mm	3	6

All frames come with a full set of link blocks and cross bars. Powder coating is available in RAL and NTSC code.

### System frame 16<sup>2</sup>/<sub>3</sub> accessories

Order code	Item no.	Description
K002.ZSHS	002.10000134.00	Leg holder corner position
K002.ZSHSG	002.10000135.00	Leg holder side frame position
K002.TWIST2LOCK	630.10000088.00	Twist2Lock with M10 thread
K002.TWIST2CLAD	630.10000089.00	Twist2Clad for 12mm front panel

### Deck plywood birch black 21mm with locks and corner protection

Order code	Item no.	Description	Length	Width
K002.MP21-2/1KV	002.10000049.00	Deck plywood 21mm, black, with locks, 3x20mm felt and corner protection	2000mm	1000mm
K002.MP21-1/1KV	002.10000050.00	Deck plywood 21mm, black, with locks, 3x20mm felt and corner protection	1000mm	1000mm

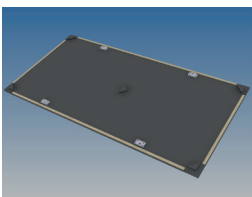

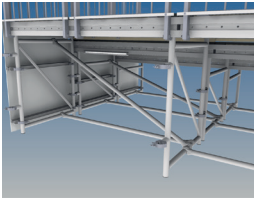

## V-frames 16<sup>2</sup>/<sub>3</sub> cm step height

Order code	Item no.	Description	Height
K005.VR333	005.10000070.00	V-frame 333	333mm
K005.VR500	005.10000089.00	V-frame 500	500mm
K005.VR666	005.10000093.00	V-frame 666	666mm
K005.VR833	005.10000098.00	V-frame 833	833mm
K005.VR1000	005.10000023.00	V-frame 1000	1000mm
K005.VR1166	005.10000025.00	V-frame 1166	1166mm
K005.VR1333	005.10000031.00	V-frame 1333	1333mm
K005.VR1500	005.10000035.00	V-frame 1500	1500mm
K005.VR1666	005.10000039.00	V-frame 1666	1666mm
K005.VR1833	005.10000043.00	V-frame 1833	1833mm
K005.VR2000	005.10000045.00	V-frame 2000	2000mm
K005.VR2166	005.10000047.00	V-frame 2166	2166mm
K005.VR2333	005.10000050.00	V-frame 2333	2333mm
K005.VR2500	005.10000054.00	V-frame 2500	2500mm
K005.VR2666	005.10000057.00	V-frame 2666	2666mm
K005.VR2833	005.10000062.00	V-frame 2833	2833mm
K005.VR3000	005.10000064.00	V-frame 3000	3000mm
K005.VR3166	005.10000066.00	V-frame 3166	3166mm
K005.VR3333	005.10000071.00	V-frame 3333	3333mm
K005.VR3500	005.10000073.00	V-frame 3500	3500mm
K005.VR3666	005.10000076.00	V-frame 3666	3666mm
K005.VR3833	005.10000079.00	V-frame 3833	3833mm
K005.VR4000	005.10000081.00	V-frame 4000	4000mm
K005.VR4166	005.10000082.00	V-frame 4166	4166mm
K005.VR4333	005.10000085.00	V-frame 4333	4333mm
K005.VR4500	005.10000088.00	V-frame 4500	4500mm

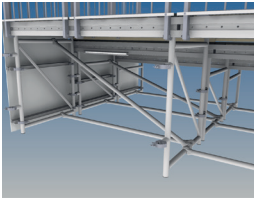

### V-frames 9/18cm step height

Order code	Item no.	Description	Height
K005.VR360	005.10000074.00	V-frame 360	360mm
K005.VR450	005.10000087.00	V-frame 450	450mm
K005.VR540	005.10000090.00	V-frame 540	540mm
K005.VR630	005.10000092.00	V-frame 630	630mm
K005.VR720	005.10000094.00	V-frame 720	720mm
K005.VR810	005.10000097.00	V-frame 810	810mm
K005.VR900	005.10000099.00	V-frame 900	900mm
K005.VR990	005.10000100.00	V-frame 990	990mm
K005.VR1080	005.10000024.00	V-frame 1080	1080mm
K005.VR1170	005.10000026.00	V-frame 1170	1170mm
K005.VR1260	005.10000030.00	V-frame 1260	1260mm
K005.VR1350	005.10000032.00	V-frame 1350	1350mm
K005.VR1440	005.10000034.00	V-frame 1440	1440mm
K005.VR1530	005.10000036.00	V-frame 1530	1530mm
K005.VR1620	005.10000038.00	V-frame 1620	1620mm
K005.VR1710	005.10000040.00	V-frame 1710	1710mm
K005.VR1800	005.10000042.00	V-frame 1800	1800mm
K005.VR1980	005.10000044.00	V-frame 1980	1980mm
K005.VR2160	005.10000046.00	V-frame 2160	2160mm
K005.VR2340	005.10000051.00	V-frame 2340	2340mm
K005.VR2520	005.10000055.00	V-frame 2520	2520mm
K005.VR2700	005.10000059.00	V-frame 2700	2700mm
K005.VR2880	005.10000063.00	V-frame 2880	2880mm
K005.VR3060	005.10000065.00	V-frame 3060	3060mm
K005.VR3240	005.10000068.00	V-frame 3240	3240mm

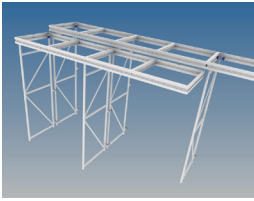

### V-frames 20cm step height

Order code	Item no.	Description	Height
K005.VR400	005.10000080.00	V-frame 400	400mm
K005.VR600	005.10000091.00	V-frame 600	600mm
K005.VR800	005.10000096.00	V-frame 800	800mm
K005.VR1000	005.10000023.00	V-frame 1000	1000mm
K005.VR1200	005.10000027.00	V-frame 1200	1200mm
K005.VR1400	005.10000033.00	V-frame 1400	1400mm
K005.VR1600	005.10000037.00	V-frame 1600	1600mm
K005.VR1800	005.10000042.00	V-frame 1800	1800mm
K005.VR2000	005.10000045.00	V-frame 2000	2000mm
K005.VR2200	005.10000048.00	V-frame 2200	2200mm
K005.VR2400	005.10000052.00	V-frame 2400	2400mm
K005.VR2600	005.10000056.00	V-frame 2600	2600mm
K005.VR2800	005.10000061.00	V-frame 2800	2800mm
K005.VR3000	005.10000064.00	V-frame 3000	3000mm
K005.VR3200	005.10000067.00	V-frame 3200	3200mm
K005.VR3400	005.10000072.00	V-frame 3400	3400mm
K005.VR3600	005.10000075.00	V-frame 3600	3600mm
K005.VR3800	005.10000078.00	V-frame 3800	3800mm
K005.VR4000	005.10000081.00	V-frame 4000	4000mm
K005.VR4200	005.10000083.00	V-frame 4200	4200mm
K005.VR4400	005.10000086.00	V-frame 4400	4400mm

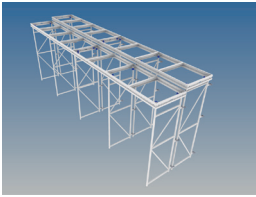

### V-frames 25cm step height

Order code	Item no.	Description	Height
K005.VR500	005.10000089.00	V-frame 500	500mm
K005.VR750	005.10000095.00	V-frame 750	750mm
K005.VR1000	005.10000023.00	V-frame 1000	1000mm
K005.VR1250	005.10000029.00	V-frame 1250	1250mm
K005.VR1500	005.10000035.00	V-frame 1500	1500mm
K005.VR1750	005.10000041.00	V-frame 1750	1750mm
K005.VR2000	005.10000045.00	V-frame 2000	2000mm
K005.VR2250	005.10000049.00	V-frame 2250	2250mm
K005.VR2500	005.10000054.00	V-frame 2500	2500mm
K005.VR2750	005.10000060.00	V-frame 2750	2750mm
K005.VR3000	005.10000064.00	V-frame 3000	3000mm
K005.VR3250	005.10000069.00	V-frame 3250	3250mm
K005.VR3500	005.10000073.00	V-frame 3500	3500mm
K005.VR3750	005.10000077.00	V-frame 3750	3750mm
K005.VR4000	005.10000081.00	V-frame 4000	4000mm
K005.VR4250	005.10000084.00	V-frame 4250	4250mm
K005.VR4500	005.10000088.00	V-frame 4500	4500mm

## Twist2Clad front panels

Order code	Item no.	Description	Height
K005.FB16-80TL	005.20000074.00	Front panel Twist2Clad, length 800mm	166mm
K005.FB16-100TL	005.20000002.00	Front panel Twist2Clad, length 1000mm	166mm
K005.FB16-120TL	005.20000073.00	Front panel Twist2Clad, length 1200mm	166mm
K005.FB16-120TL-LED	005.20000003.00	Front panel Twist2Clad, length 1200mm LED	166mm
K005.FB16-150TL	005.20000076.00	Front panel Twist2Clad, length 1500mm	166mm
K005.FB16-200TL	005.20000001.00	Front panel Twist2Clad, length 2000mm	166mm
K005.FB20-80TL	005.20000078.00	Front panel Twist2Clad, length 800mm	200mm
K005.FB20-100TL	005.20000007.00	Front panel Twist2Clad, length 1000mm	200mm
K005.FB20-120TL	005.20000079.00	Front panel Twist2Clad, length 1200mm	200mm
K005.FB20-120TL-LED	005.20000081.00	Front panel Twist2Clad, length 1200mm LED	200mm
K005.FB20-150TL	005.20000080.00	Front panel Twist2Clad, length 1500mm	200mm
K005.FB20-200TL	005.20000005.00	Front panel Twist2Clad, length 2000mm	200mm
K005.FB33-80TL	005.20000024.00	Front panel Twist2Clad, length 800mm	333mm
K005.FB33-100TL	005.20000022.00	Front panel Twist2Clad, length 1000mm	333mm
K005.FB33-120TL	005.20000083.00	Front panel Twist2Clad, length 1200mm	333mm
K005.FB33-120TL-LED	005.20000021.00	Front panel Twist2Clad, length 1200mm LED	333mm
K005.FB33-150TL	005.20000084.00	Front panel Twist2Clad, length 1500mm	333mm
K005.FB33-200TL	005.20000023.00	Front panel Twist2Clad, length 2000mm	333mm
K005.FB40-80TL	005.20000098.00	Front panel Twist2Clad, length 800mm	400mm
K005.FB40-100TL	005.20000013.00	Front panel Twist2Clad, length 1000mm	400mm
K005.FB40-120TL	005.20000099.00	Front panel Twist2Clad, length 1200mm	400mm
K005.FB40-120TL-LED		Front panel Twist2Clad, length 1200mm LED	400mm
K005.FB40-150TL	005.20000100.00	Front panel Twist2Clad, length 1500mm	400mm
K005.FB40-200TL	005.20000101.00	Front panel Twist2Clad, length 2000mm	400mm

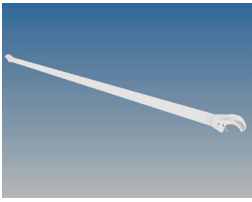

## Bracings for V-frames

Order code	Item no.	Description
K002.HR868	002.10000116.00	Horizontal bracing 868
K002.HR1000	002.10000110.00	Horizontal bracing 1000
K002.HR1132	002.10000111.00	Horizontal bracing 1132
K002.HR1868	002.10000112.00	Horizontal bracing 1868
K002.HR2000	002.10000113.00	Horizontal bracing 2000
K002.HR2132	002.10000114.00	Horizontal bracing 2132
K002.HR2868	002.10000115.00	Horizontal bracing 2868
K002.DR666	002.10000018.00	Diagonal bracing 666
K002.DR1000	002.10000016.00	Diagonal bracing 1000
K002.DR1333	002.10000017.00	Diagonal bracing 1333

## System frame 16<sup>2</sup>/<sub>3</sub> accessories

Order code	Item no.	Description
K002.VRR200	002.10000108.00	Lifting roller 200
K002.VRR300	002.10000109.00	Lifting roller 300
K005.TVS125	005.10000019.00	Single step L/W/H 1200 x 270 x 125
K005.TVS166	005.10000277.00	Single step L/W/H 1200 x 270 x 166
K005.TVS200	005.10000021.00	Single step L/W/H 1200 x 270 x 200
K005.SB	005.10000157.00	LED strip 90cm for system frame or single step use
K005.SBT.DMX	005.20000247.00	Transformer with battery for emergency light, for 10 units
K005.SBM	005.10000283.00	Connection cable
K002.SG1-16	002.10000249.00	Safety railing, black powder coated, 1m wide
K005.GPS166	005.10000168.00	Railing extension 166mm
K005.GPS125	005.10000013.00	Railing extension 125mm

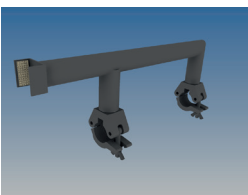

K005.GPS

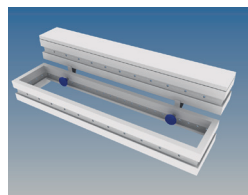

K005.TVS

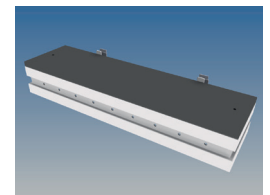

K005.TVS





## Telescopic riser system 20

Order code	Item no.	Description	Width riser	Number of steps
K005.TT2000-20-3	005.10000004.00	Telescopic riser with 20cm step height, total width 2m, 3 steps	2000mm	3
K005.TT2000-20-4	005.10000005.00	Telescopic riser with 20cm step height, total width 2m, 4 steps	2000mm	4
K005.TT2000-20-5	005.10000006.00	Telescopic riser with 20cm step height, total width 2m, 5 steps	2000mm	5
K005.TT2500-20-3	005.10000001.00	Telescopic riser with 20cm step height, total width 2.5m, 3 steps	2500mm	3
K005.TT2500-20-4	005.10000002.00	Telescopic riser with 20cm step height, total width 2.5m, 4 steps	2500mm	4
K005.TT2500-20-5	005.10000003.00	Telescopic riser with 20cm step height, total width 2.5m, 5 steps	2500mm	5

After setup the total depth is 1000mm x number of steps.

Depth of the block in storage varies regarding the number of steps, maximum is 1250mm (5 steps).

The front of the riser is covered with plywood, black.

Riser comes without additional steps, railings or lighting. See additional accessories.

Side railings are connected to the riser with bolts.

Back railing is our standard safety railing.

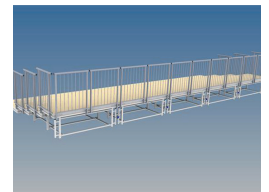
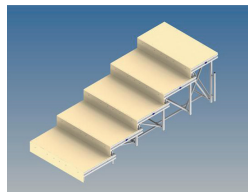
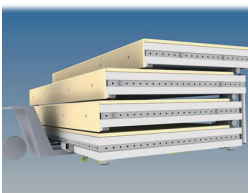

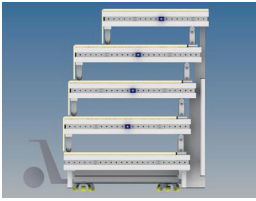

## Telescopic riser system 33

Order code	Item no.	Description	Width riser	Number of steps
K005.TT2000-33-3	005.10000106.00	Telescopic riser with 33cm step height, total width 2m, 3 steps	2000mm	3
K005.TT2000-33-4	005.10000107.00	Telescopic riser with 33cm step height, total width 2m, 4 steps	2000mm	4
K005.TT2000-33-5	005.10000012.00	Telescopic riser with 33cm step height, total width 2m, 5 steps	2000mm	5
K005.TT2500-33-3	005.10000103.00	Telescopic riser with 33cm step height, total width 2.5m, 3 steps	2500mm	3
K005.TT2500-33-4	005.10000104.00	Telescopic riser with 33cm step height, total width 2.5m, 4 steps	2500mm	4
K005.TT2500-33-5	005.10000105.00	Telescopic riser with 33cm step height, total width 2.5m, 5 steps	2500mm	5

## Telescopic riser accessories

Order code	Item no.	Description
K005.TTSG1-16	005.10000017.00	Safety railing, 100Kg side load, connected with bolts.
K002.SG1-16	002.10000249.00	Safety railing, black powder coated, 1m wide
K002.SG0-16	002.10000130.00	Safety railing, black powder coated, 0.5m wide
K005.GPS166	005.10000168.00	Railing extension 166mm
K005.TTW	005.10000022.00	Trolley for moving stored block
K005.TTH	005.10000028.00	Pallet wagon for lifting and moving
K005.TVS166	005.10000277.00	Single step L/W/H 1200 x 270 x 166
K005.SB	005.10000157.00	LED strip 90cm for system frame or single step use
K005.SBT.DMX	005.20000247.00	Transformer with battery for emergency light, for 10 units
K005.SBM	005.10000283.00	Connection cable

## 6. HOAC<sup>®</sup> SET DESIGN

- 6.1 TackIt and accessories
- 6.2 Unibeam and accessories
- 6.3 3D System Frame without wood
- 6.4 3D System Frame with spruce inlay
- 6.5 3D System Frame profiles and accessories
- 6.6 3D System Frame accessories
- 6.7 Flip2Play 1m x 0.5m
- 6.8 Flip2Play 1m x 1m
- 6.9 Flip2Play 2m x 0.5m
- 6.10 Flip2Play 2m x 1m
- 6.T Technical data

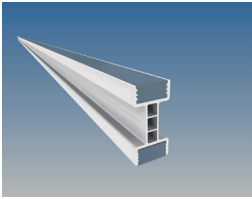

## Tacklt profiles

Order code	Item no.	Description	L/mm
K006.T80-6	110.10000013.00	Tacklt profile	6020mm
K006.T80-8	110.10000029.00	Tacklt profile	8020mm
K006.T80-W6	006.10000016.00	Tacklt profile, single side wood	6020mm
K006.T80-W8		Tacklt profile, single side wood	8020mm
K006.T80-P6	006.10000017.00	Tacklt profile, single side PVC B1	6020mm
K006.T80-P8	006.10000067.00	Tacklt profile, single side PVC B1	8020mm
K006.T80-DPG6	006.10000064.00	Tacklt profile, double side PVC B1	6020mm
K006.T80-DPG8		Tacklt profile, double side PVC B1	8020mm
00.CB		Bending 6m length (min. radius 1000mm)	
00.CC		One cut (45°- 90°)	
00.CCD		One cut 90° and drilling a 12mm hole on both sides	
00.CD		Drilling 12mm holes every 10cm in a 6m length	
00.CD8		Drilling 12mm holes every 10cm in a 8m length	

## Tacklt accessories

Order code	Item no.	Description
K006.TC90	006.10000049.00	Tacklt 90° corner for frame and cross brace
K006.TC90S	006.10000012.00	Tacklt 90° corner for projection/lighting frames, shadowless
K006.TLC	006.10000014.00	Tacklt straight connector
K006.TCB100	006.10000002.00	Cross bar Ø48mm for frame width 1000mm
K006.TCB120	006.10000003.00	Cross bar Ø48mm for frame width 1200mm
K006.TCB140	006.10000004.00	Cross bar Ø48mm for frame width 1400mm
K006.TB3	006.10000005.00	Diagonal bracing for counterweight or screw fixing, 2-3m high
K006.TB4	006.10000006.00	Diagonal bracing for counterweight or screw fixing, 3-4m high



K006.TC90

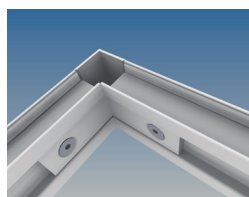

K006.TC90S



06.TB3 / 06.TCB100

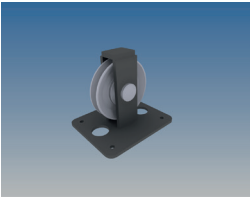

## Uni-beam 33 1/3

Order code	Item no.	Description	Weight
K006.UZ1	006.10000019.00	Uni-beam 1000mm	3,5 Kg
K006.UZ2	006.10000020.00	Uni-beam 2000mm	6,0 Kg
K006.UZ3	006.10000022.00	Uni-beam 3000mm	8,5 Kg
K006.UZ4	006.10000023.00	Uni-beam 4000mm	11,0 Kg
K006.UZ5	006.10000024.00	Uni-beam 5000mm	13,0 Kg
K006.UZ6	006.10000025.00	Uni-beam 6000mm	16,0 Kg

## Uni-beam cross sections

Order code	Item no.	Description	Length
K006.UZE	006.10000009.00	Uni-beam bridge part	920mm
K006.UZR	006.10000010.00	Uni-beam edge part	940mm
K006.UZM	006.10000008.00	Uni-beam middle part	960mm

## Uni-beam accessories

Order code	Item no.	Description
K006.UZS	006.10000001.00	Extra connection welded
K006.UZW1	006.10000026.00	Corner
K006.UZG	006.10000007.00	Hinge
K006.UZW2	006.10000027.00	Cube

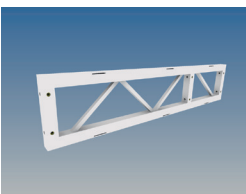

K006.UZ2

### 3D System Frame 16<sup>2</sup>/<sub>3</sub> with holes for wood inlay fixing

Order code	Item no.	Length	Width	Cross bars	Link blocks
K002.3DZ1/1-16	002.10001302.00	1000mm	1000mm	0	4
K002.3DZ2/1-16	002.10001022.00	2000mm	1000mm	1	4
K002.3DZ3/1-16	002.10001002.00	3000mm	1000mm	2	5
K002.3DZ4/1-16	002.10001177.00	4000mm	1000mm	3	6
K002.3DZ5/1-16	002.10001055.00	5000mm	1000mm	4	7
K002.3DZ6/1-16	002.10001003.00	6000mm	1000mm	5	8
K002.3DZ0/0-16	002.10001057.00	500mm	500mm	0	2
K002.3DZ1/0-16	002.10001303.00	1000mm	500mm	0	3
K002.3DZ2/0-16	002.10001021.00	2000mm	500mm	1	3
K002.3DZ3/0-16	002.10001060.00	3000mm	500mm	2	4
K002.3DZ4/0-16	002.10001061.00	4000mm	500mm	3	5
K002.3DZ5/0-16	002.10001062.00	5000mm	500mm	4	6
K002.3DZ6/0-16	002.10001063.00	6000mm	500mm	5	7

### 3D System Frame 16<sup>2</sup>/<sub>3</sub> welded with spruce inlay

Order code	Item no.	Length	Width	Cross bars	Link blocks
K002.3DZ1/1-16F	002.10001007.00	1000mm	1000mm	0	4
K002.3DZ2/1-16F	002.10001015.00	2000mm	1000mm	1	4
K002.3DZ3/1-16F	002.10001014.00	3000mm	1000mm	2	5
K002.3DZ4/1-16F	002.10001054.00	4000mm	1000mm	3	6
K002.3DZ5/1-16F	002.10001055.00	5000mm	1000mm	4	7
K002.3DZ6/1-16F	002.10001056.00	6000mm	1000mm	5	8
K002.3DZ0/0-16F	002.10001057.00	500mm	500mm	0	2
K002.3DZ1/0-16F	002.10001058.00	1000mm	500mm	0	3
K002.3DZ2/0-16F	002.10001059.00	2000mm	500mm	1	3
K002.3DZ3/0-16F	002.10001060.00	3000mm	500mm	2	4
K002.3DZ4/0-16F	002.10001061.00	4000mm	500mm	3	5
K002.3DZ5/0-16F	002.10001062.00	5000mm	500mm	4	6
K002.3DZ6/0-16F	002.10001063.00	6000mm	500mm	5	7

### 3D System Frame profile

Order code	Item no.	Description	Length
K002.3DZ16-6	110.10000106.00	3D System Frame profile 16 <sup>2</sup> / <sub>3</sub>	6055mm
K002.3DZ16-G6	002.10001020.00	3D System Frame profile 16 <sup>2</sup> / <sub>3</sub> , with 12mm holes	6055mm

### 3D System Frame accessories

Order code	Item no.	Description	Length
K002.ZE04	002.10000118.00	Link block incl. 2x M10 Star Knob Bolt	
K002.3DZR1000	002.10001005.00	3D cross bar 1m	940mm
K002.3DZR500	002.10001023.00	3D cross bar 0.5m	440mm
K002.3DZR1000F	002.10001065.00	3D cross bar 1m, spruce wood filling	940mm
K002.3DZR500F	002.10001064.00	3D cross bar 0.5m, spruce wood filling	440mm
K002.ZE05	002.10000039.00	Corner connector 90°, incl. 2x M10x18 bolt	
K002.ZSHS	002.10000134.00	Leg holder corner position	
K002.ZSHSG	002.10000135.00	Leg holder side frame position	



### 3D System wall and ceiling accessories

Order code	Description
K006.3DWV	Wall connector 90°
K006.3DWV2	Compensation for thickness of the frame covering 2mm
K006.3DWV3	Compensation for thickness of the frame covering 3mm
K006.3DWV5	Compensation for thickness of the frame covering 5mm
K006.3DWA16	Wagon bracket for wagon height 166mm, floor space 20mm
K006.3DWA20	Wagon bracket for wagon height 200mm, floor space 20mm
K006.3DAL500	Suspension plate, 500Kg
K006.TB3	Diagonal bracing with floor mounting plate for counterweight, 2-3m high
K006.TB4	Diagonal bracing with floor mounting plate for counterweight, 3-4m high
K002.ZVC	1m connection bar with 2x M10 bolts
K002.ZVC0.5	0.5m connection bar with 2x M10 bolts
K001.TH300-700/2	Doughty O-ring, 500Kg load capacity

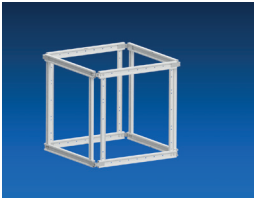

## Flip2Play rostrum with Twist2Clad-Technology 1m x 0.5m

Order code	Item no.	Length	Width	Height	Link blocks
K006.F2P1/0.5-20	006.10000129.00	1000mm	500mm	200mm	4
K006.F2P1/0.5-33	006.10000130.00	1000mm	500mm	333mm	4
K006.F2P1/0.5-40	006.10000131.00	1000mm	500mm	400mm	4
K006.F2P1/0.5-50	006.10000132.00	1000mm	500mm	500mm	4
K006.F2P1/0.5-60	006.10000133.00	1000mm	500mm	600mm	4
K006.F2P1/0.5-66	006.10000134.00	1000mm	500mm	666mm	4
K006.F2P1/0.5-80	006.10000135.00	1000mm	500mm	800mm	4
K006.F2P1/0.5-83	006.10000136.00	1000mm	500mm	833mm	4
K006.F2P1/0.5-100	006.10000096.00	1000mm	500mm	1000mm	4
K006.F2P1/0.5-116	006.10000119.00	1000mm	500mm	1166mm	8
K006.F2P1/0.5-120	006.10000120.00	1000mm	500mm	1200mm	8
K006.F2P1/0.5-133	006.10000121.00	1000mm	500mm	1333mm	8
K006.F2P1/0.5-140	006.10000122.00	1000mm	500mm	1400mm	8
K006.F2P1/0.5-150	006.10000123.00	1000mm	500mm	1500mm	8
K006.F2P1/0.5-160	006.10000124.00	1000mm	500mm	1600mm	8
K006.F2P1/0.5-166	006.10000125.00	1000mm	500mm	1666mm	8
K006.F2P1/0.5-180	006.10000126.00	1000mm	500mm	1800mm	8
K006.F2P1/0.5-183	006.10000127.00	1000mm	500mm	1833mm	8
K006.F2P1/0.5-200	006.10000128.00	1000mm	500mm	2000mm	8

## Flip2Play accessories

Order code	Item no.	Description	Length	Width
K002.MP21-1/0KV	002.10000048.00	Deck plywood 21mm, black, with locks, 3x20mm felt and corner protection	1000mm	500mm
K002.Twist2Lock	630.10000088.00	Twist2Lock with M10 thread		
K002.Twist2Clad	630.10000089.00	Twist2Clad for 12mm front panels		
K002.F2P01		Flip2Play connector set		

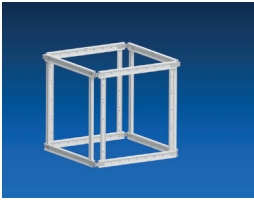

## Flip2Play rostrum with Twist2Clad-Technology 1m x 1m

Order code	Item no.	Length	Width	Height	Link blocks
K006.F2P1/1-20	006.10000111.00	1000mm	1000mm	200mm	4
K006.F2P1/1-33	006.10000112.00	1000mm	1000mm	333mm	4
K006.F2P1/1-40	006.10000113.00	1000mm	1000mm	400mm	4
K006.F2P1/1-50	006.10000114.00	1000mm	1000mm	500mm	4
K006.F2P1/1-60	006.10000115.00	1000mm	1000mm	600mm	4
K006.F2P1/1-66	006.10000116.00	1000mm	1000mm	666mm	4
K006.F2P1/1-80	006.10000117.00	1000mm	1000mm	800mm	4
K006.F2P1/1-83	006.10000118.00	1000mm	1000mm	833mm	4
K006.F2P1/1-100	006.10000095.00	1000mm	1000mm	1000mm	4
K006.F2P1/1-116	006.10000101.00	1000mm	1000mm	1166mm	8
K006.F2P1/1-120	006.10000102.00	1000mm	1000mm	1200mm	8
K006.F2P1/1-133	006.10000103.00	1000mm	1000mm	1333mm	8
K006.F2P1/1-140	006.10000104.00	1000mm	1000mm	1400mm	8
K006.F2P1/1-150	006.10000105.00	1000mm	1000mm	1500mm	8
K006.F2P1/1-160	006.10000106.00	1000mm	1000mm	1600mm	8
K006.F2P1/1-166	006.10000107.00	1000mm	1000mm	1666mm	8
K006.F2P1/1-180	006.10000108.00	1000mm	1000mm	1800mm	8
K006.F2P1/1-183	006.10000109.00	1000mm	1000mm	1833mm	8
K006.F2P1/1-200	006.10000110.00	1000mm	1000mm	2000mm	8

## Flip2Play Zubehör

Order code	Item no.	Description	Length	Width
K002.MP21-1/1KV	002.10000050.00	Deck plywood 21mm, black, with locks, 3x20mm felt and corner protection	1000mm	1000mm
K002.Twist2Lock	630.10000088.00	Twist2Lock with M10 thread		
K002.Twist2Clad	630.10000089.00	Twist2Clad for 12mm front panels		
K002.F2P01		Flip2Play connector set		

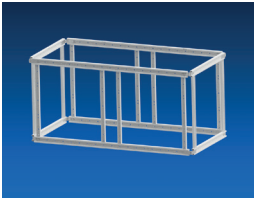

## Flip2Play rostrum with Twist2Clad-Technology 2m x 0.5m

Order code	Item no.	Length	Width	Height	Link blocks
K006.F2P2/0.5-20	006.10000201.00	2000mm	500mm	200mm	4
K006.F2P2/0.5-33	006.10000202.00	2000mm	500mm	333mm	4
K006.F2P2/0.5-40	006.10000203.00	2000mm	500mm	400mm	4
K006.F2P2/0.5-50	006.10000204.00	2000mm	500mm	500mm	4
K006.F2P2/0.5-60	006.10000205.00	2000mm	500mm	600mm	4
K006.F2P2/0.5-66	006.10000206.00	2000mm	500mm	666mm	4
K006.F2P2/0.5-80	006.10000207.00	2000mm	500mm	800mm	4
K006.F2P2/0.5-83	006.10000208.00	2000mm	500mm	833mm	4
K006.F2P2/0.5-100	006.10000100.00	2000mm	500mm	1000mm	4
K006.F2P2/0.5-116	006.10000191.00	2000mm	500mm	1166mm	8
K006.F2P2/0.5-120	006.10000192.00	2000mm	500mm	1200mm	8
K006.F2P2/0.5-133	006.10000193.00	2000mm	500mm	1333mm	8
K006.F2P2/0.5-140	006.10000194.00	2000mm	500mm	1400mm	8
K006.F2P2/0.5-150	006.10000195.00	2000mm	500mm	1500mm	8
K006.F2P2/0.5-160	006.10000196.00	2000mm	500mm	1600mm	8
K006.F2P2/0.5-166	006.10000197.00	2000mm	500mm	1666mm	8
K006.F2P2/0.5-180	006.10000198.00	2000mm	500mm	1800mm	8
K006.F2P2/0.5-183	006.10000199.00	2000mm	500mm	1833mm	8
K006.F2P2/0.5-200	006.10000200.00	2000mm	500mm	2000mm	8

## Flip2Play accessories

Order code	Item no.	Description	Length	Width
K002.MP21-2/0KV	002.10000047.00	Deck plywood 21mm, black, with locks, 3x20mm felt and corner protection	2000mm	500mm
K002.Twist2Lock	630.10000088.00	Twist2Lock with M10 thread		
K002.Twist2Clad	630.10000089.00	Twist2Clad for 12mm front panels		
K002.F2P01		Flip2Play connector set		

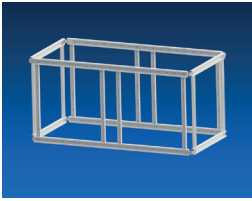

## Flip2Play rostrum with Twist2Clad-Technology 2m x 1m

Order code	Item no.	Length	Width	Height	Link blocks
K006.F2P2/1-20	006.10000087.00	2000mm	1000mm	200mm	4
K006.F2P2/1-33	006.10000088.00	2000mm	1000mm	333mm	4
K006.F2P2/1-40	006.10000089.00	2000mm	1000mm	400mm	4
K006.F2P2/1-50	006.10000090.00	2000mm	1000mm	500mm	4
K006.F2P2/1-60	006.10000091.00	2000mm	1000mm	600mm	4
K006.F2P2/1-66	006.10000092.00	2000mm	1000mm	666mm	4
K006.F2P2/1-80	006.10000093.00	2000mm	1000mm	800mm	4
K006.F2P2/1-83	006.10000094.00	2000mm	1000mm	833mm	4
K006.F2P2/1-100	006.10000075.00	2000mm	1000mm	1000mm	4
K006.F2P2/1-116	006.10000077.00	2000mm	1000mm	1166mm	8
K006.F2P2/1-120	006.10000078.00	2000mm	1000mm	1200mm	8
K006.F2P2/1-133	006.10000079.00	2000mm	1000mm	1333mm	8
K006.F2P2/1-140	006.10000080.00	2000mm	1000mm	1400mm	8
K006.F2P2/1-150	006.10000081.00	2000mm	1000mm	1500mm	8
K006.F2P2/1-160	006.10000082.00	2000mm	1000mm	1600mm	8
K006.F2P2/1-166	006.10000083.00	2000mm	1000mm	1666mm	8
K006.F2P2/1-180	006.10000084.00	2000mm	1000mm	1800mm	8
K006.F2P2/1-183	006.10000085.00	2000mm	1000mm	1833mm	8
K006.F2P2/1-200	006.10000086.00	2000mm	1000mm	2000mm	8

## Flip2Play accessories

Order code	Item no.	Description	Length	Width
K002.MP21-2/1KV	002.10000049.00	Deck plywood 21mm, black, with locks, 3x20mm felt and corner protection	2000mm	1000mm
K002.Twist2Lock	630.10000088.00	Twist2Lock with M10 thread		
K002.Twist2Clad	630.10000089.00	Twist2Clad for 12mm front panels		
K002.F2P01		Flip2Play connector set		

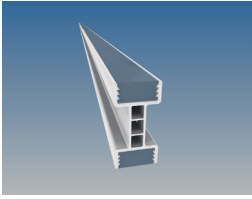

### TackIt profile - technical data

System	Profile height [mm]	Profile width [mm]	Material	Cross sectional area [cm <sup>2</sup> ]	Weight [Kg/m]
TackIt Profile	80,00	40,00	ENAW6063T66	6,66	1,8

System	Moment of inertia [l/cm <sup>4</sup> ]	Moment of resistance [W/cm <sup>3</sup> ]	Line load per. [kN/m], free span 2m	Point load per. [kN/m], free span 2m
TackIt Profile	37,18	9,3	1,95	1,95

## 7. **HOAC**<sup>®</sup> FLY BAR SYSTEMS

7.1 Fly bar truss system 300/150/3

7.2 StarTrack 1

7.3 StarTrack 2

7.T Technical data

## Fly bar truss 300/150/3M

Order code	Item no.	Description	Length
K007.500/300/150/3MB	007.10000047.00	Fly bar truss system 300/150/3M, powder coated in black	500mm
K007.1000/300/150/3MB	007.10000048.00	Fly bar truss system 300/150/3M, powder coated in black	1000mm
K007.1500/300/150/3MB	007.10000049.00	Fly bar truss system 300/150/3M, powder coated in black	1500mm
K007.2000/300/150/3MB	007.10000050.00	Fly bar truss system 300/150/3M, powder coated in black	2000mm
K007.2500/300/150/3MB	007.10000051.00	Fly bar truss system 300/150/3M, powder coated in black	2500mm
K007.3000/300/150/3MB	007.20000009.00	Fly bar truss system 300/150/3M, powder coated in black	3000mm
K007.3500/300/150/3MB	007.10000053.00	Fly bar truss system 300/150/3M, powder coated in black	3500mm
K007.4000/300/150/3MB	007.10000054.00	Fly bar truss system 300/150/3M, powder coated in black	4000mm
K007.4500/300/150/3MB	007.10000055.00	Fly bar truss system 300/150/3M, powder coated in black	4500mm
K007.5000/300/150/3MB	007.10000056.00	Fly bar truss system 300/150/3M, powder coated in black	5000mm
K007.5500/300/150/3MB	007.10000057.00	Fly bar truss system 300/150/3M, powder coated in black	5500mm
K007.6000/300/150/3MB	007.10000041.00	Fly bar truss system 300/150/3M, powder coated in black	6000mm

## Fly bar truss accessories

Order code	Description
K007.TH300/150/3S6	Suspension for rope 6-8mm, incl. half turnbuckle, welded to the truss
K007.TH300/150/3	Suspension for shackle 1to
K007.MASSBAND	Tape measuring sticker, split into left and right part

**Attention:** The listed length and the pricing is just for orientation. With the order of fly bars, we will handle them as a customer project, because length and also the position of the hanging points welded to the truss will be different for each customer.



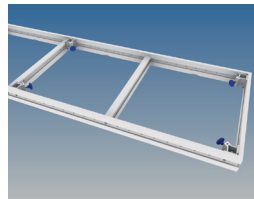
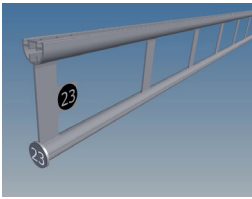

## StarTrack 1

Order code	Item no.	Description	Length
K007.ST-500	007.10000058.00	StarTrack 1, black anodized, high grade aluminium	500mm
K007.ST-1000	007.10000059.00	StarTrack 1, black anodized, high grade aluminium	1000mm
K007.ST-1500	007.10000060.00	StarTrack 1, black anodized, high grade aluminium	1500mm
K007.ST-2000	007.10000061.00	StarTrack 1, black anodized, high grade aluminium	2000mm
K007.ST-2500	007.10000062.00	StarTrack 1, black anodized, high grade aluminium	2500mm
K007.ST-3000	007.10000010.00	StarTrack 1, black anodized, high grade aluminium	3000mm
K007.ST-3500	007.10000063.00	StarTrack 1, black anodized, high grade aluminium	3500mm
K007.ST-4000	007.10000026.00	StarTrack 1, black anodized, high grade aluminium	4000mm
K007.ST-4500	007.10000044.00	StarTrack 1, black anodized, high grade aluminium	4500mm
K007.ST-5000	007.10000045.00	StarTrack 1, black anodized, high grade aluminium	5000mm
K007.ST-5500	007.10000046.00	StarTrack 1, black anodized, high grade aluminium	5500mm
K007.ST-6000	007.10000007.00	StarTrack 1, black anodized, high grade aluminium	6000mm
K007.ST-6500	007.10000064.00	StarTrack 1, black anodized, high grade aluminium	6500mm
K007.ST-7000	007.10000006.00	StarTrack 1, black anodized, high grade aluminium	7000mm
K007.ST-7500		StarTrack 1, black anodized, high grade aluminium	7500mm
K007.ST-8000	007.10000066.00	StarTrack 1, black anodized, high grade aluminium	8000mm

## StarTrack 1 Zubehör

Bestellnummer	Beschreibung
K007.ST-A6	Suspension for rope 6-8mm deflected 90°, incl. half turnbuckle, black
K007.ST-A1TO	Suspension for spare chain link NG10, black
K007.ST-V	Connector set for StarTrack 1
K007.ST-VQ	Connector set for StarTrack 1 Quicklock, used for fly bar extension
K007.ST-E	End plate with space for number sticker, black
K007.MASSBAND	Tape measuring sticker, split into left and right part
K007.ST-SVSOC	StarTrack 1 power distributor Socapex
K007.ST-SV6	StarTrack 1 power distribution Harting B16 into 6x Schuko

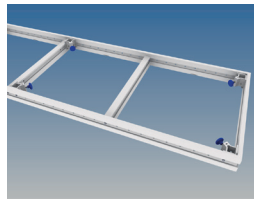
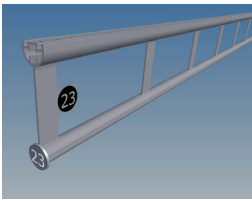

## StarTrack 2

Order code	Item no.	Description	Length
K007.ST2-500	007.10000068.00	StarTrack 2 black anodized, high grade aluminium	500mm
K007.ST2-1000	007.10000069.00	StarTrack 2 black anodized, high grade aluminium	1000mm
K007.ST2-1500	007.10000070.00	StarTrack 2 black anodized, high grade aluminium	1500mm
K007.ST2-2000	007.10000071.00	StarTrack 2 black anodized, high grade aluminium	2000mm
K007.ST2-2500	007.10000072.00	StarTrack 2 black anodized, high grade aluminium	2500mm
K007.ST2-3000	007.10000073.00	StarTrack 2 black anodized, high grade aluminium	3000mm
K007.ST2-3500	007.10000074.00	StarTrack 2 black anodized, high grade aluminium	3500mm
K007.ST2-4000	007.10000075.00	StarTrack 2 black anodized, high grade aluminium	4000mm
K007.ST2-4500	007.10000076.00	StarTrack 2 black anodized, high grade aluminium	4500mm
K007.ST2-5000		StarTrack 2 black anodized, high grade aluminium	5000mm
K007.ST2-5500	007.10000078.00	StarTrack 2 black anodized, high grade aluminium	5500mm
K007.ST2-6000	007.10000009.00	StarTrack 2 black anodized, high grade aluminium	6000mm
K007.ST2-6500	007.10000079.00	StarTrack 2 black anodized, high grade aluminium	6500mm
K007.ST2-7000	007.10000080.00	StarTrack 2 black anodized, high grade aluminium	7000mm
K007.ST2-7500	007.10000081.00	StarTrack 2 black anodized, high grade aluminium	7500mm
K007.ST2-8000	007.10000082.00	StarTrack 2 black anodized, high grade aluminium	8000mm

## StarTrack 2 accessories

Order code	Description
K007.ST2-A6	Suspension for rope 6-8mm deflected 90°, incl. half turnbuckle, black
K001.TH300-700/2	Doughty O-ring
K007.ST2-V	Connector set for StarTrack 2
K007.ST2-VQ	Connector set for StarTrack 2 Quicklock, used for fly bar extension
K007.ST2-E	End plate with space for number sticker, black
K007.MASSBAND	Tape measuring sticker, split into left and right part
K007.ST2-SVSOC	StarTrack 2 power distributor Socapex
K007.ST2-SV6	StarTrack 2 power distributor Harting B16 into 6x Schuko

## 8. **HOAC**<sup>®</sup> TRACK SYSTEMS

8.1 Silent Move and accessories

8.2 Silent Move FlyMe 1D

8.3 Silent Move FlyMe 1D for 60mm fly bar

8.4 Electrical motor options

8.T Technical data

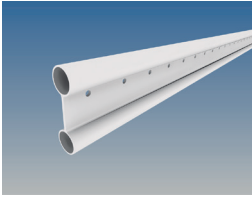

## Silent Move profiles

Order code	Item no.	Description	Length
K008.SM-GB6	008.10000021.00	Silent Move profile, incl. holes Ø12mm, black anodized	5995mm
K008.SM-GB1	008.10000039.00	Silent Move profile, incl. holes Ø12mm, black anodized	995mm
K008.SM-GB2	008.10000037.00	Silent Move profile, incl. holes Ø12mm, black anodized	1995mm
K008.SM-GB3	008.10000038.00	Silent Move profile, incl. holes Ø12mm, black anodized	2995mm
K008.SM-GB4	008.10000062.00	Silent Move profile, incl. holes Ø12mm, black anodized	3995mm
K008.SM-GB5	008.10000066.00	Silent Move profile, incl. holes Ø12mm, black anodized	4995mm
K008.SM-G6	008.10000020.00	Silent Move profile, incl. holes Ø12mm	5995mm
K008.SM-G1	008.10000036.00	Silent Move profile, incl. holes Ø12mm	995mm
K008.SM-G2	008.10000033.00	Silent Move profile, incl. holes Ø12mm	1995mm
K008.SM-G3	008.10000035.00	Silent Move profile, incl. holes Ø12mm	2995mm
K008.SM-G4	008.10000034.00	Silent Move profile, incl. holes Ø12mm	3995mm
K008.SM-G5	008.10000091.00	Silent Move profile, incl. holes Ø12mm	4995mm
K008.SM-C6	008.10000022.00	Silent Move profile, incl. 100x16mm cutouts	5995mm
K008.SM-C1		Silent Move profile, incl. 100x16mm cutouts	995mm
K008.SM-C2		Silent Move profile, incl. 100x16mm cutouts	1995mm
K008.SM-C3		Silent Move profile, incl. 100x16mm cutouts	2995mm
K008.SM-C4		Silent Move profile, incl. 100x16mm cutouts	3995mm
K008.SM-C5		Silent Move profile, incl. 100x16mm cutouts	4995mm

## Silent Move profiles

Order code	Item no.	Description	Length
K008.SM-CB6	008.10000023.00	Silent Move profile, incl. 100x16mm cutouts, black anodized	5995mm
K008.SM-CB1		Silent Move profile, incl. 100x16mm cutouts, black anodized	995mm
K008.SM-CB2	008.10000100.00	Silent Move profile, incl. 100x16mm cutouts, black anodized	1995mm
K008.SM-CB3		Silent Move profile, incl. 100x16mm cutouts, black anodized	2995mm
K008.SM-CB4	008.10000099.00	Silent Move profile, incl. 100x16mm cutouts, black anodized	3995mm
K008.SM-CB5		Silent Move profile, incl. 100x16mm cutouts, black anodized	4995mm

## Silent Move accessories

Order code	Item no.	Description
K008.SMTC	008.10000018.00	Silent Move carriage, load capacity 375Kg acc. to DGUV V17
K008.SMTCC	008.10000017.00	Silent Move cable trolley, load capacity 60Kg
K008.SMS48	008.10000003.00	Suspension Ø48-50mm, load capacity 460Kg acc. to DGUV V17
K008.SMS60	008.10000004.00	Suspension Ø60mm, load capacity 460Kg acc. to DGUV V17
K008.SMS60120	008.10000001.00	Suspension 60x120mm, load capacity 460Kg acc. to DGUV V17
K008.SMSS48	008.10000005.00	Swivel suspension Ø48mm, load capacity 375Kg acc. to DGUV V17
K008.SMSDS	008.10000002.00	Suspension Doughty Side Entry Ø48mm for Silent Move with cutouts, load capacity 375Kg acc. to DGUV V17
K008.SMC	008.10000025.00	Silent Move connector set
K008.SME	008.10000012.00	Silent Move end stop
K008.SMEH	008.10000109.00	Silent Move end stop heavy duty

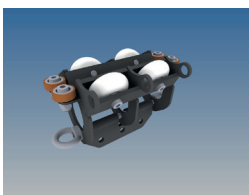

K008.SMTC



K008.SMS48

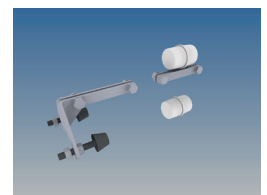

K008.SME  
K008.SMC

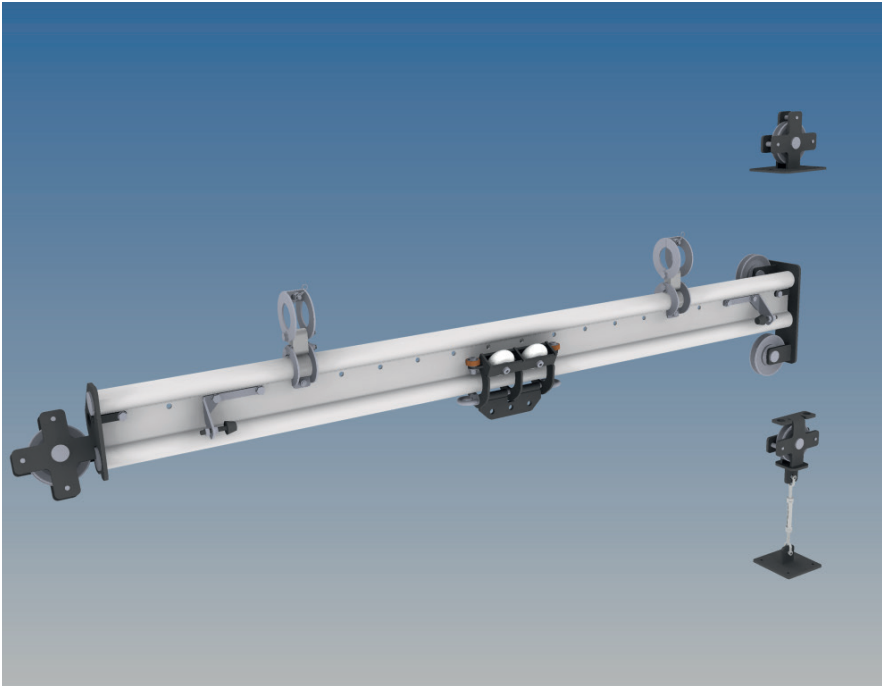

## Silent Move flying accessories

Order code	Item no.	Description
K008.SMSP	008.10000014.00	Silent Move single horizontal deflection pulley
K008.SMDP	008.10000009.00	Silent Move double deflection pulley up / down
K008.SMDPD	008.10000006.00	Silent Move double deflection pulley down / down
K008.SMSPF	008.10000045.00	Silent Move single vertical deflection pulley for stage floor, adjustable by turnbuckle
K008.SMSPG	008.10000027.00	Silent Move single vertical deflection pulley for fly loft grid floor, fixing has to be done by customer
K008.SMR	008.10000024.00	Silent Move rope 10.5mm, black

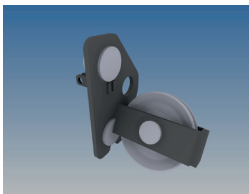

K008.SMSP

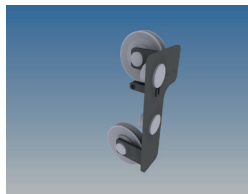

K008.SMDP

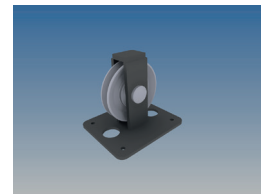

K008.SMSPF

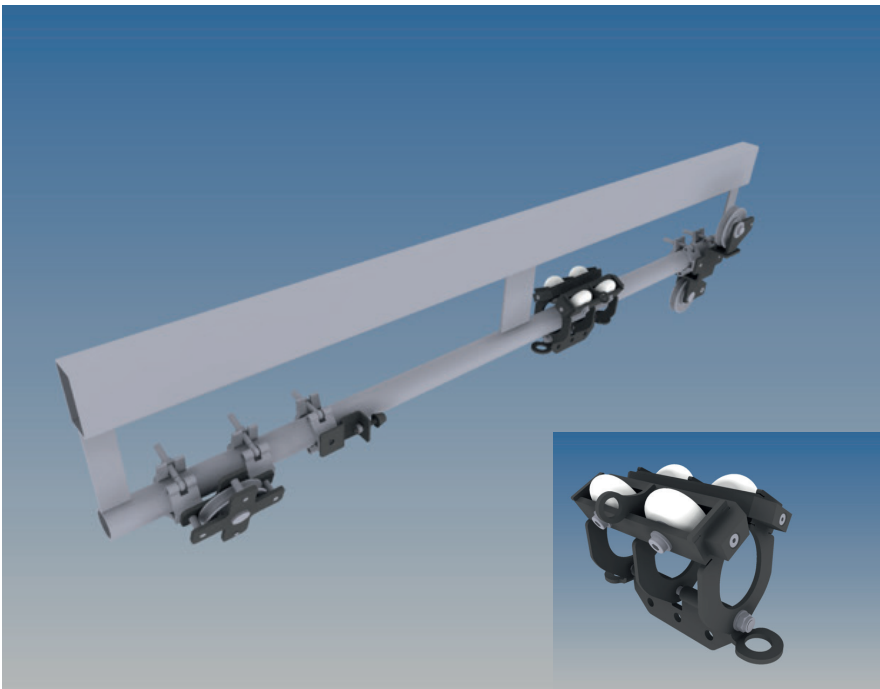

### Silent Move flying accessories for 60mm fly bar

Order code	Item no.	Description
K008.SMTC60	008.10000019.00	Silent Move carriage, load capacity 375Kg, for Ø60mm fly bar
K008.SME60	008.10000013.00	Silent Move end stop, for Ø60mm fly bar
K008.SMSP60	008.10000016.00	Silent Move single horizontal deflection pulley, for Ø60mm fly bar
K008.SMDP60	008.10000011.00	Silent Move double deflection pulley up/down, for Ø60mm fly bar
K008.SMDPD60		Silent Move double deflection pulley down/down, for Ø60mm fly bar
K008.SMSPF	008.10000045.00	Silent Move single vertical deflection pulley for stage floor, adjustable by turnbuckle
K008.SMSPG	008.10000027.00	Silent Move single vertical deflection pulley for fly loft grid floor, fixing has to be done by customer
K008.SMR	008.10000024.00	Silent Move rope 10.5mm, black

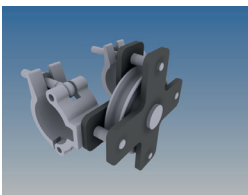

K008.SMSP60

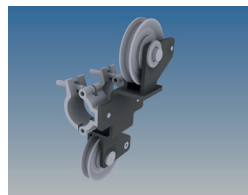

K008.SMDP60

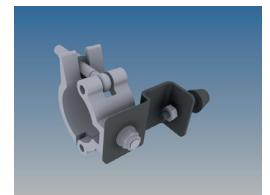

K008.SME60

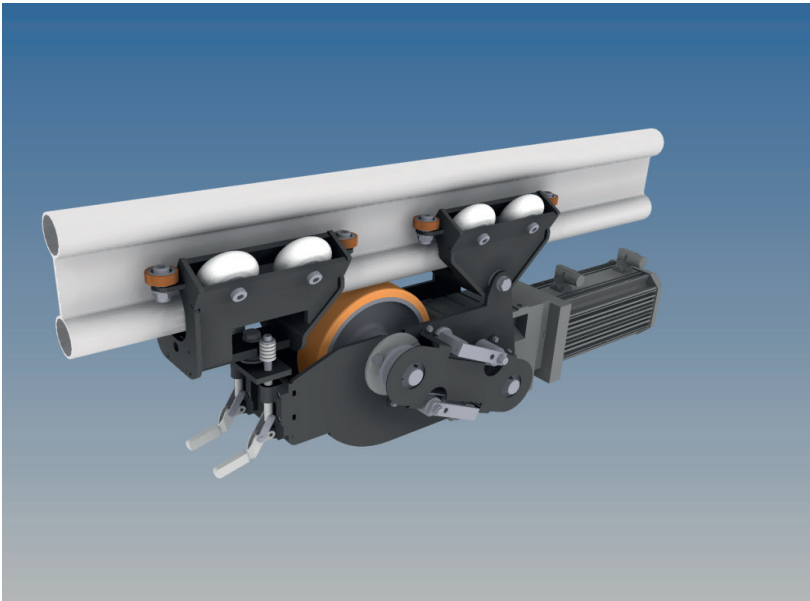

Silent Move H-Drive for horizontal Movement up to 2m/sec.

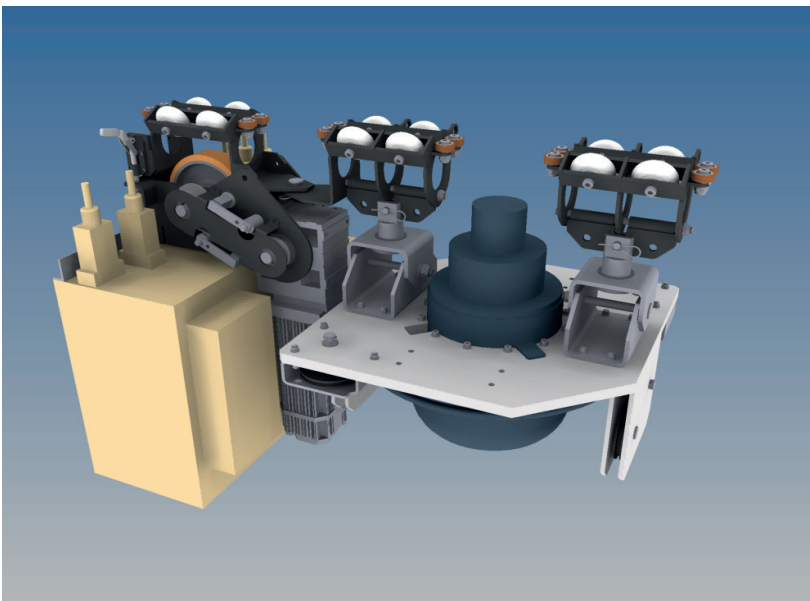

Silent Move H-Drive for horizontal movement up to 2m/sec.  
with additional vertical drive (can be adapted for different drive options)



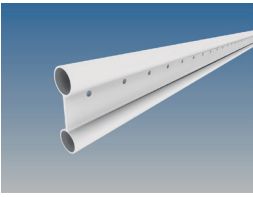

### Silent Move profile - technical data

System	Profile height [mm]	Profile width [mm]	Material	Cross sectional area (cm <sup>2</sup> )	Weight [Kg/m]
SM Profile	170,00	50,00	ENAW6063T66	13,19	3,58

System	Moment of inertia [l/cm <sup>4</sup> ]	Moment of resistance [W/cm <sup>3</sup> ]	Line load per. [kN/m], free span 2m	Point load per. [kN/m], free span 2m
SM Profile	362,21	43,32	9,10	9,10

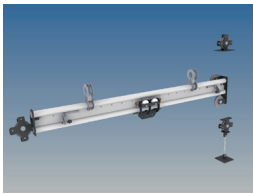

### Permitted single load F [kN] with suspension every 2m

System	F [kN] suspension 1m	F [kN] suspension 1.5m	F [kN] suspension 2m	F [kN] suspension 2.5m
SM Profile	4.0	4.0	2.77	1.45

